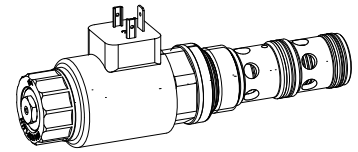

**Proportional 3-way flow control valve
Screw-in cartridge**

- Direct operated, pressure compensated
- $Q_{max} = 100 \text{ l/min}$, $p_{max} = 350 \text{ bar}$
- $Q_{Nmax} = 63 \text{ l/min}$

M33 x 2
 ISO 7789

DESCRIPTION

Direct operated, pressure compensated proportional flow control valve as a screw-in cartridge with a thread M33x2 for cavity acc. to ISO 7789. Two flow ranges are available. The volume flow is adjusted by a Wandfluh proportional solenoid (VDE standard 0580). The cartridge body is made of steel. A special surface treatment guarantees a good protection against corrosion and wear as well as very good low-friction characteristics of the pressure compensating- and throttle spool. The solenoid coil is zinc-/nickel-coated.

FUNCTION

The 3-way flow control valve serves for maintaining the speed of a consumer constant independent of the load. Superfluous pump output flow is fed into the return flow system in a cost saving manner, and as a result, prevents an overheating of the hydraulic system. The power controlled, proportional solenoid running in oil acts directly on the throttle spool, which opens the throttle segments in the cartridge body. Proportional to the current demand of the proportional solenoid, the throttle aperture changes, and with this the volume flow. In case of a current-free solenoid, the throttle spool is held in closed position by a spring. For driving the valve, Wandfluh proportional amplifiers are available (see Register 1.13).

APPLICATION

Proportional flow control valves are suitable for feed control systems, where the consumer flow has to be maintained constant with a changing load. The screw-in cartridge is suitable for installation in control blocs as well as in flange- and sandwich valves of the size NG10. Cavity tools are available for machining the cartridge cavities in steel and aluminium (for hire or for purchase). Please refer to the data sheets in Reg. 2.13 of our documentation.

TYPE CODE

		Q D P PM33 - <input type="checkbox"/> - <input type="checkbox"/> / <input type="checkbox"/> <input type="checkbox"/> - <input type="checkbox"/> <input type="checkbox"/> # <input type="checkbox"/>	
Flow control valve			
3-way			
Proportional			
Screw-in cartridge M33x2			
Nominal volume flow rates Q_N	32 l/min <input type="checkbox"/> 32 63 l/min <input type="checkbox"/> 63		
Nominal voltage U_N	12 VDC <input type="checkbox"/> G12 24 VDC <input type="checkbox"/> G24 without coil <input type="checkbox"/> X5		
Slip-on coil	Metal housing, round <input type="checkbox"/> W Metal housing, square <input type="checkbox"/> M*		
Connection execution	Connector socket EN 175301-803 / ISO 4400 <input type="checkbox"/> D Connector socket AMP Junior-Timer <input type="checkbox"/> J Connector Deutsch DT04-2P <input type="checkbox"/> G		
Sealing material	NBR <input type="checkbox"/> FKM (Viton) <input type="checkbox"/> D1		
Manual override	Armature tube closed (standard) <input type="checkbox"/> Screwed sealing plug <input type="checkbox"/> HB0 Manual emergency actuation <input type="checkbox"/> HB4.5		
Design-Index (Subject to change)			

* Only available in conjunction with other nominal voltages and connection versions. (See data sheet 1.1-181)

SYMBOLS

simplified

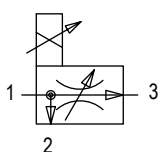

detailed

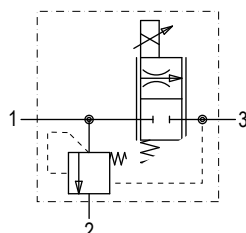
GENERAL SPECIFICATIONS

Description	3-way proportional flow control valve
Construction	Screw-in cartridge for cavity acc. to ISO 7789
Operation	Proportional solenoid
Mounting	Screw-in thread M33x2
Ambient temperature	-20...50 °C
Mounting position	any
Fastening torque	$M_D = 80 \text{ Nm}$ for screw-in cartridge $M_D = 7 \text{ Nm}$ for knurled nut
Weight	$m = 1,00 \text{ kg}$
Flow direction	see symbol

ELECTRICAL SPECIFICATIONS

Construction	Proportional solenoid, wet pin push type, pressure tight	
Standard nominal voltage	U = 12 VDC	U = 24 VDC
Limiting current	I _G = 1560 mA	I _G = 780 mA
Relative duty factor	100 % ED/DF (see data sheet 1.1-430)	
Protection class acc. to EN 60 529	Connection version D: IP65 J: IP66 G: IP67 and 69K	

For further electrical specifications see data sheet 1.1-180 (W)
1.1-181 (M)

HYDRAULIC SPECIFICATIONS

Fluid	Mineral oil, other fluid on request
Contamination efficiency	ISO 4406:1999, class 18/16/13 (Required filtration grade $\beta_{6...10} \geq 75$) see data sheet 1.0-50/2
Viscosity range	12 mm ² /s...320 mm ² /s
Fluid temperature	-20...+70 °C
Peak pressure	p _{max} = 350 bar
Nominal volume flow rates	Q _N = 32 l/min, 63 l/min
Max. volume flow	Q _{max} = 100 l/min (1 → 2)
Min. volume flow	Q _{min} = 0,4 l/min
Hysteresis	≤ 5% * * at optimal dither signal

CHARACTERISTICS Oil viscosity $\nu = 30 \text{ mm}^2/\text{s}$

Q = f (I) Volume flow adjustment characteristics 1 → 3 (p₃ = 100 bar)

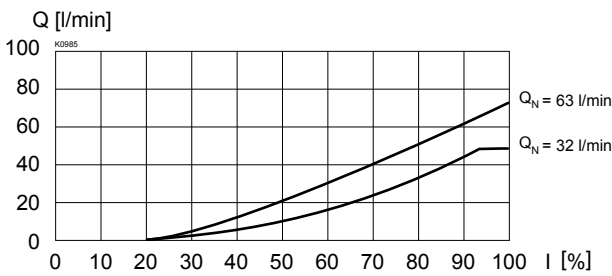

Q = f (p) Volume flow pressure characteristics (I = I_G)

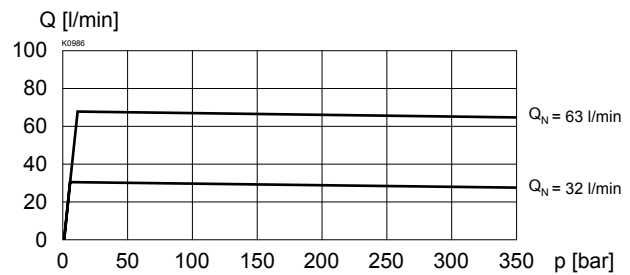

$\Delta p = f(Q)$ Pressure drop-volume flow characteristics 1 → 2 (I = 0 mA)

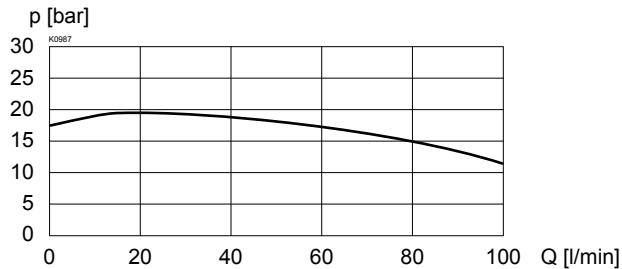

$\Delta p = f(Q)$ Pressure drop-volume flow characteristics 1 → 3 (I = I_G)

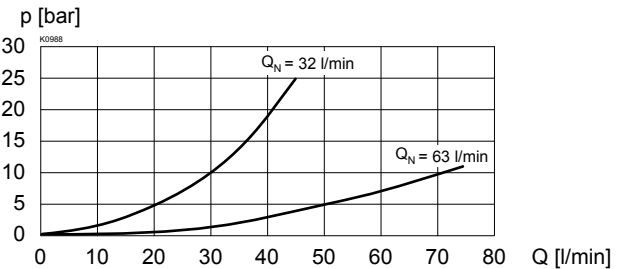

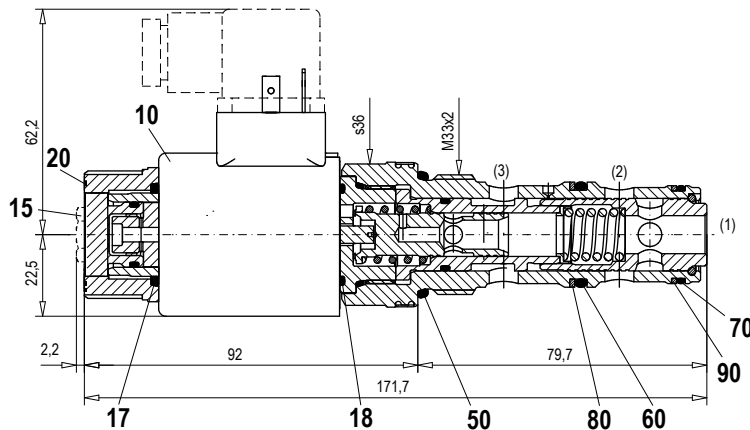
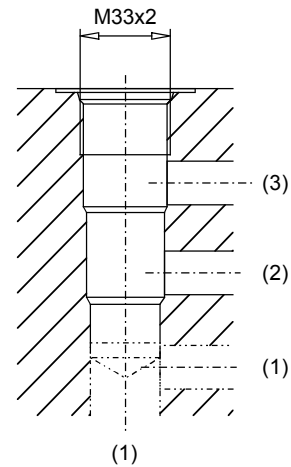
DIMENSIONS / SECTIONAL DRAWINGS

 Cavity drawing acc. to
 ISO 7789-33-04-0-98

 For detailed cavity drawing and
 cavity tools see data sheet 2.13-1040

PARTS LIST

Position	Article	Description
10	206.1200	EN 175301 Solenoid coil WDS45/23x50-G24
	206.1203	Solenoid coil WDS45/23x50-G12
		Junior-Timer
	206.1201	Solenoid coil WJS45/23x50-G24
	206.1204	Solenoid coil WJS45/23x50-G12
206.1202		Deutsch Solenoid coil WGS45/23x50-G24
	206.1205	Solenoid coil WGS45/23x50-G12
15	253.8000	HB 4,5 anual override (data sheet 1.1-300)
	239.2033	HB 0 Plug screw (data sheet 1.1-300)
17	160.2222	O-ring ID 22,22x2,62 (NBR)
18	160.2220	O-ring ID 21,95x1,78 (NBR)
20	154.2701	Knurled nut
50	160.2298	O-ring ID 29,82x2,62 (NBR)
	160.6296	O-ring ID 29,82x2,62 (FKM)
60	160.2238	O-ring ID 23,81x2,62 (NBR)
	160.6238	O-ring ID 23,81x2,62 (FKM)
70	160.2236	O-ring ID 23,52x1,78 (NBR)
	160.6236	O-ring ID 23,52x1,78 (FKM)
80	049.3297	Backup ring RD 24,5x29x1,4
90	049.3276	Backup ring RD 24,1x27x1,4

ACCESSORIES

Flange and sandwich bodies	Data sheet 2.6-862
Line mount body	Data sheet 2.9-210
Proportional amplifier	Register 1.13
Mating connector EN 175301-803	Article no. 219.2002

Technical explanation see data sheet 1.0-100