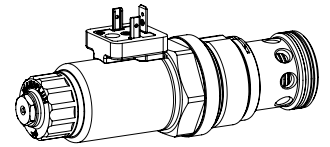

Proportional pressure relief cartridge

- ◆ pilot operated
- ◆ $Q_{max} = 400$ l/min
- ◆ $p_{max} = 400$ bar
- ◆ $p_{Nmax} = 350$ bar

M42 x 2
ISO 7789

DESCRIPTION

Pilot operated proportional pressure relief valve in screw-in cartridge construction for cavity according to ISO 7789. High flow capacity, very sensitively adjustable. When the operating pressure adjusted by means of the proportional solenoid is reached, the valve opens and connects the protected line with the drain to the tank. The back pressure in T (2) affects the pressure in P (1). For the control, Wandfluh proportional amplifiers are available (see register 1.13).

APPLICATION

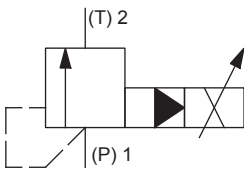
The electrical remote control in conjunction with process controls allows economical solutions with repeatable processes. The screw-in cartridge is perfectly suitable for installation in control blocks. For machining the cartridge cavity in steel and aluminum blocks, cavity tools are available (hire or purchase). Please refer to the data sheets in register 2.13.

SYMBOL

ACTUATION

Actuation	Proportional solenoid, wet pin push type, pressure tight
Execution	W.S37 / 19 x 50 (Data sheet 1.1-173) M.S35 / 19 x 50 (Data sheet 1.1-174)
Connection	Connector socket EN 175301 – 803 Connector socket AMP Junior-Timer Connector Deutsch DT04 – 2P

TYPE CODE

Pressure relief valve			B	V	P	PM42	-	<input type="text"/>	-	<input type="text"/>	/	<input type="text"/>	<input type="text"/>	-	<input type="text"/>	#	<input type="text"/>
Pilot operated																	
Proportional																	
Screw-in cartridge M22 x 1,5																	
Nominal pressure range p_N	100 bar	<input type="text" value="100"/>	275 bar	<input type="text" value="275"/>													
	200 bar	<input type="text" value="200"/>	350 bar	<input type="text" value="350"/>													
Nominal voltage U_N	12 VDC	<input type="text" value="G12"/>															
	24 VDC	<input type="text" value="G24"/>															
	without coil	<input type="text" value="X5"/>															
Slip-on coil	Metal housing round	<input type="text" value="W"/>															
	Metal housing square	<input type="text" value="M"/>															
Connection execution	Connector socket EN 175301-803 / ISO 4400	<input type="text" value="D"/>															
	Connector socket AMP Junior - Timer	<input type="text" value="J"/>															
	Connector Deutsch DT04 - 2P	<input type="text" value="G"/>															
Sealing material	NBR	<input type="text"/>															
	FKM (Viton)	<input type="text" value="D1"/>															
Manual override	Manual override	<input type="text" value="HB4,5"/>															
	Screw plug	<input type="text" value="HB0"/>															
Design index (subject to change)																	

2.3-590

GENERAL SPECIFICATIONS

Designation	Proportional pressure relief valve
Construction	Pilot operated
Mounting	Screw-in cartridge construction
Nominal size	M42 x 2 according to ISO 7789
Actuation	Proportional solenoid
Ambient temperature	-25...+70 °C
Weight	0,90 kg
MTTFd	150 years

ELECTRICAL SPECIFICATIONS

Protection class	Connection execution D: IP65 Connection execution J: IP66 Connection execution G: IP67 and IP69K
Relative duty factor	100 % DF
Standard nominal voltage	12 VDC, 24 VDC
Limiting current at 50 °C	$I_G = 1320 \text{ mA (} U_N = 12\text{VDC)}$ $I_G = 660 \text{ mA (} U_N = 24\text{VDC)}$

Note! Other electrical specifications see data sheet 1.1-173 (slip-on coil W) and 1.1-174 (slip-on coil M)



HYDRAULIC SPECIFICATIONS

Working pressure	$p_{\text{max}} = 400 \text{ bar}$
Tank pressure	$p_{\text{T max}} = p_p + 15 \text{ bar}$
Nominal pressure range	$P_N = 100 \text{ bar, } 200 \text{ bar, } 275 \text{ bar, } 350 \text{ bar}$
Volume flow range	$Q = 5 \dots 400 \text{ l/min}$
Leakage oil	See characteristics
Hysteresis	$\leq 5 \%$ at optimal dither signal
Repeatability	$\leq 2 \%$ at optimal dither signal
Fluid	Mineral oil, other fluid on request
Viscosity range	$12 \text{ mm}^2/\text{s} \dots 320 \text{ mm}^2/\text{s}$
Temperature range fluid	-25...+70 °C (NBR) -20...+70 °C (FKM)
Contamination efficiency	Class 18 / 16 / 13
Filtration	Required filtration grade $\beta_{6 \dots 10} \geq 75$, see data sheet 1.0-50

PERFORMANCE SPECIFICATIONS

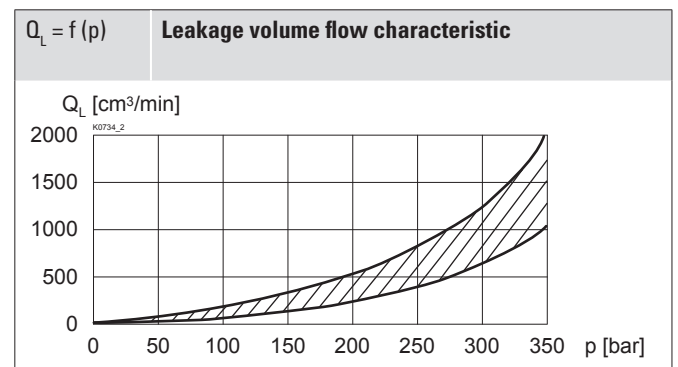
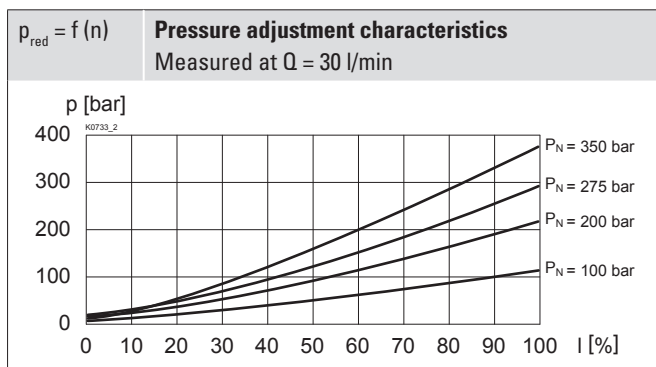
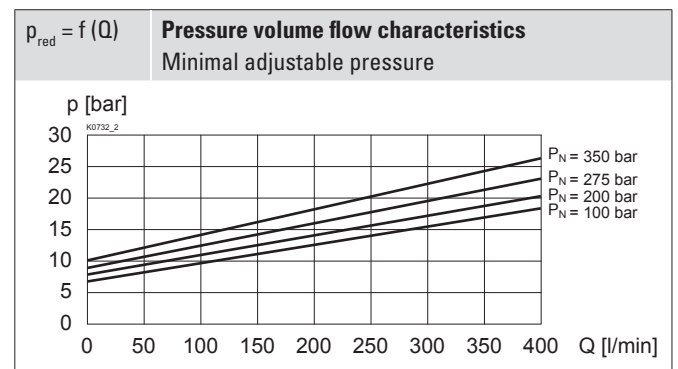
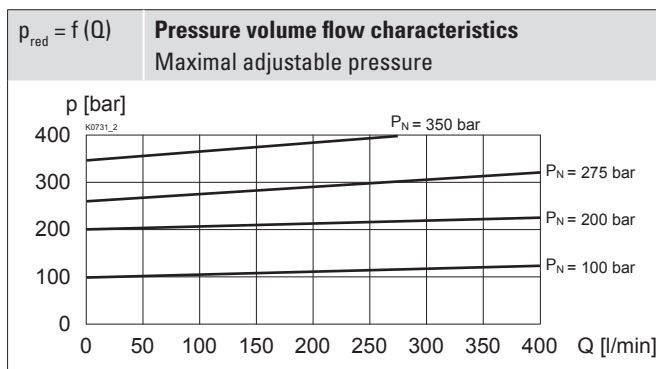
Oil viscosity $\nu = 30 \text{ mm}^2/\text{s}$

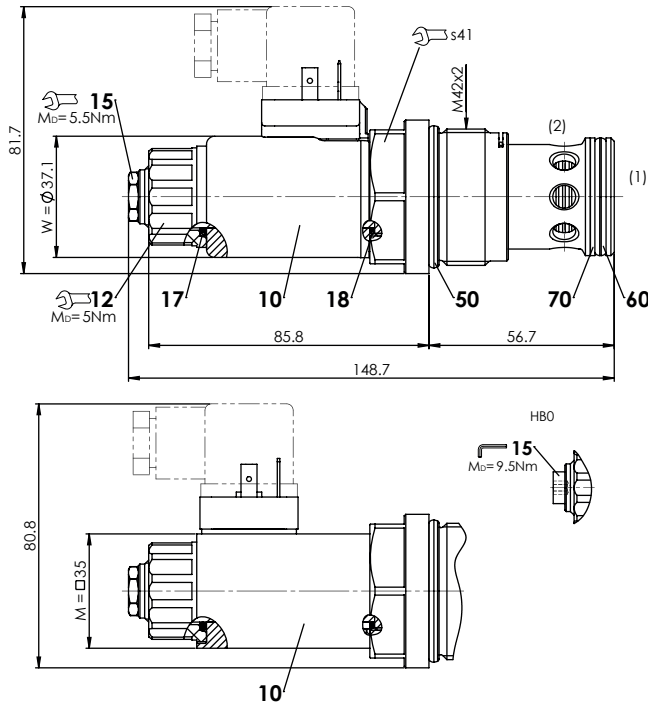

DIMENSIONS

HYDRAULIC CONNECTION

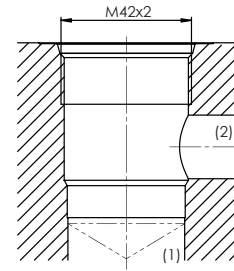
Cavity drawing according to ISO 7789-42-02-0-07

Note!

For detailed cavity drawing and cavity tools see data sheet 2.13-1048

PARTS LIST

Position	Article	Description
10	206.2... 260.5...	W.S37 / 19 x 50 M.S35 / 19 x 50
12	154.2700	Knurled nut
15	253.8000 239.2033	HB4,5 manual override HBO Screw plug
17	160.2187	O-ring ID 18,72 x 2,62 (NBR)
18	160.2170	O-ring ID 17,17 x 1,78 (NBR)
50	160.2377 160.6379	O-ring ID 37,77 x 2,62 (NBR) O-ring ID 37,77 x 2,62 (FKM)
60	160.2314 160.6315	O-ring ID 31,42 x 2,62 (NBR) O-ring ID 31,42 x 2,62 (FKM)
70	049.8364	Backup ring PTSM rd 29,1 x 33,6 x 1,4

ACCESSORIES

Proportional amplifier	Register 1.13
Electric plug B (black)	Article no. 219.2002
Threaded body	Data sheet 2.9-200
Technical explanations	Data sheet 1.0-100
Hydraulic fluids	Data sheet 1.0-50
Filtration	Data sheet 1.0-50

MANUAL OVERRIDE

HB4,5

Optionally: Screw plug (HBO), no actuation possible

SURFACE TREATMENT

- ◆ The cartridge body, the slip-on coil and the armature tube are zinc-nickel coated

SEALING MATERIAL

NBR or FKM (Viton) as standard, choice in the type code

STANDARDS

Cartridge cavity	ISO 7789
Solenoids	DIN VDE 0580
Connection execution D	EN 175301 – 803
Protection class	EN 60 529
Contamination efficiency	ISO 4406

INSTALLATION NOTES

Mounting type	Screw-in cartridge M42 x 2
Mounting position	Any, preferably horizontal
Tightening torque	$M_D = 100 \text{ Nm}$ Screw-in cartridge $M_D = 5 \text{ Nm}$ knurled nut $M_D = 9,5 \text{ Nm}$ HBO $M_D = 5,5 \text{ Nm}$ HB4,5

 Wandfluh AG Postfach CH-3714 Frutigen
 Tel. +41 33 672 72 72 Fax +41 33 672 72 12 sales@wandfluh.com