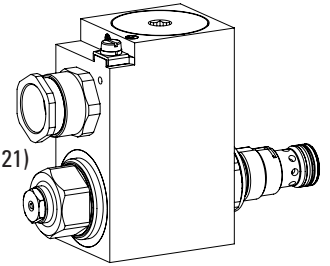

**Proportional pressure relief cartridge**

- ◆ pilot operated
- ◆  $Q_{max} = 100 \text{ l/min}$
- ◆  $p_{max} = 400 \text{ bar}$
- ◆  $p_{Nmax} = 350 \text{ bar}$

**M22 x 1,5**  
**ISO 7789**

Ex db IIC T6, T4 Gb (Zone 1)  
 Ex tb III C T80 °C, T130 °C Db (Zone 21)  
 Ex db I Mb  
 ⓧ II 2 G Ex db IIC T6, T4  
 ⓧ II 2 D Ex tb III C T80 °C, T130 °C  
 ⓧ I M2 Ex db I Mb  
 Class I, Division 1, Group A, B, C, D T4  
 Class II & III, Division I, Group E, F, G T4

**DESCRIPTION**

Pilot operated proportional pressure relief valve in screw-in cartridge construction for cavity according to ISO 7789. High flow capacity, very sensitively adjustable. When the operating pressure adjusted by means of the proportional solenoid is reached, the valve opens and connects the protected line with the drain to the tank. The back pressure in T (2) affects the pressure in P (1). For the control, Wandfluh proportional amplifiers are available (see register 1.13). The pressure tight encapsulated Ex-protection solenoid coil prevents an explosion on the inside penetrating to the outside as well as an ignitable surface temperature.

**APPLICATION**

These valves are suitable for applications in explosion-hazard areas, open cast and also in mines. The electrical remote control in conjunction with process controls allows economical solutions with repeatable processes. The screw-in cartridge is perfectly suitable for installation in control blocks and is installed in sandwich- (vertical stacked systems) and in flange plates (corresponding data sheets in this register). For machining the cartridge cavity in steel and aluminum blocks, cavity tools are available (hire or purchase). Please refer to the data sheets in register 2.13.

**TYPE CODE**

		B V B PM22 - <input type="text"/> - <input type="text"/> / <input type="text"/> / <input type="text"/> - <input type="text"/> <input type="text"/> # <input type="text"/>			
Pressure relief valve					
Pilot operated					
Proportional, explosion proof execution Ex d					
Screw-in cartridge M22 x 1,5					
Execution	L9		L15		
Nominal pressure range $p_N$ [bar]	<input type="text" value="20"/>	<input type="text" value="160"/>	<input type="text" value="20"/>	<input type="text" value="200"/>	<input type="text" value="275"/>
	<input type="text" value="50"/>	<input type="text" value="220"/>	<input type="text" value="63"/>	<input type="text" value="350"/>	
	<input type="text" value="80"/>	<input type="text" value="280"/>	<input type="text" value="100"/>		
Nominal voltage $U_N$	12 VDC	<input type="text" value="G12"/>			
	24 VDC	<input type="text" value="G24"/>			
Nominal power $P_N$	9 W	<input type="text" value="L9"/>	Ambient temperature up to: 40 °C or 90 °C 70 °C		
	15 W	<input type="text" value="L15"/>			
Certification ATEX, UKEX, IECEx, EAC, CCC	<input type="text"/>	USA / Canada	<input type="text" value="UC-M187"/>		
Australia	<input type="text" value="AU"/>	India	<input type="text" value="PE"/>		
MA	<input type="text" value="MA"/>				
Sealing material	NBR	<input type="text"/>			
	FKM (Viton)	<input type="text" value="D1"/>			
Options	without amplifier	<input type="text"/>			
		<input type="text" value="M248"/>			
Design index (subject to change)					

2.3-536

**CERTIFICATES**

	Surface	Mining	Standard -25 °C to...	M248 Electronic
ATEX / UKEX	x	x	x	x
IECEX	x	x	x	x
CCC	x	x	x	x
EAC	x	x	x	x
Australia	x	x	x	
MA		x	x	x
USA / Canada	x		x	x
PESO	x		x	x

The certificates can be found on [www.wandfluh.com](http://www.wandfluh.com)

**GENERAL SPECIFICATIONS**

Designation	Proportional pressure relief valve
Construction	Pilot operated
Mounting	Screw-in cartridge construction
Nominal size	M22 x 1,5 according to ISO 7789
Actuation	Proportional solenoid
Ambient temperature	<b>Operation as T6</b> -25...+40 °C (L9) <b>Operation as T4</b> -25...+90 °C (L9) -25...+70 °C (L15)
Weight	1,9 kg
MTTFd	150 years

**ELECTRICAL SPECIFICATIONS**

Protection class	IP65 / 66 / 67
Relative duty factor	100 % DF
Voltage tolerance	± 10 % with regard to nominal voltage
Standard nominal voltage	12 VDC, 24 VDC
Limiting current at... °C	<b>L9, 40 °C</b> $I_G = 625 \text{ mA (12 VDC)}$ $I_G = 305 \text{ mA (24 VDC)}$ <b>L15, 50 °C</b> $I_G = 950 \text{ mA (12 VDC)}$ $I_G = 450 \text{ mA (24 VDC)}$ <b>L15, 70 °C</b> $I_G = 910 \text{ mA (12 VDC)}$ $I_G = 420 \text{ mA (24 VDC)}$
Standard nominal power	9 W, 15 W
Temperature class	Nominal power 9 W: T1...T6 Nominal power 15 W: T1...T4

**Note!** Other electrical specifications see data sheet 1.1-183

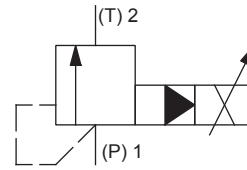
**SYMBOL**

**HYDRAULIC SPECIFICATIONS**

Working pressure	$p_{max} = 400 \text{ bar}$
Nominal pressure range	<b>Execution L9</b> $P_N = 20 \text{ bar, 50 bar, 80 bar, 160 bar, 220 bar, 280 bar}$ <b>Execution L15</b> $P_N = 20 \text{ bar, 63 bar, 100 bar, 200 bar, 275 bar, 350 bar}$
Volume flow range	$Q = 0,3...100 \text{ l/min}$
Leakage oil	See characteristics
Hysteresis	≤ 5 % at optimal dither signal
Repeatability	≤ 2 % at optimal dither signal
Fluid	Mineral oil, other fluid on request
Viscosity range	12 mm <sup>2</sup> /s...320 mm <sup>2</sup> /s
Temperature range fluid	<b>Operation as T6</b> NBR -25...+40 °C (L9) FKM -20...+40 °C (L9) <b>Operation as T4</b> NBR -25...+70 °C (L9 or L15) FKM -20...+70 °C (L9 or L15)
Contamination efficiency	Class 18 / 16 / 13
Filtration	Required filtration grade $\beta_{6...10} \geq 75$ , see data sheet 1.0-50

**ACTUATION**

Actuation	Proportional solenoid, wet pin push type, pressure tight
Execution	MKY45 / 18x60 (Data sheet 1.1-183)
Connection	Cable gland for cable $\varnothing 6,5...14 \text{ mm}$

**Attention!** The UC execution is always supplied without cable gland

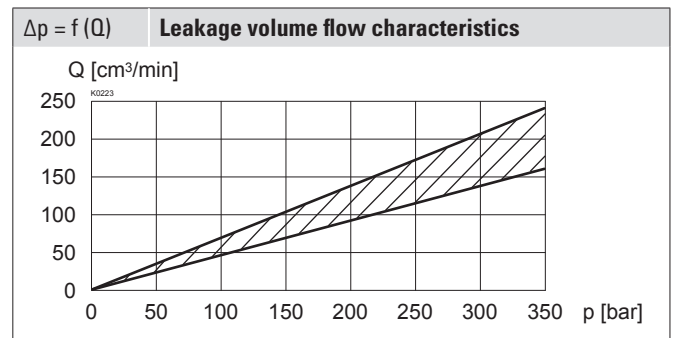
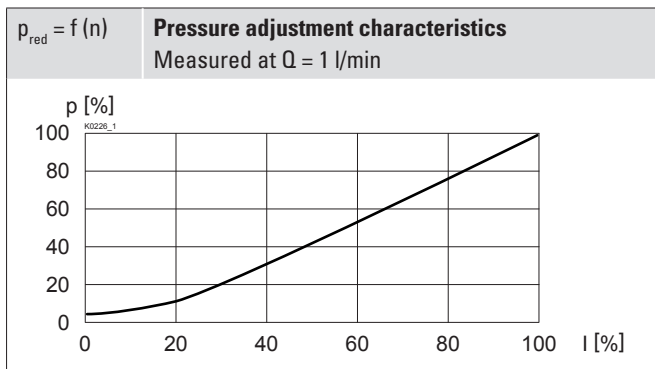
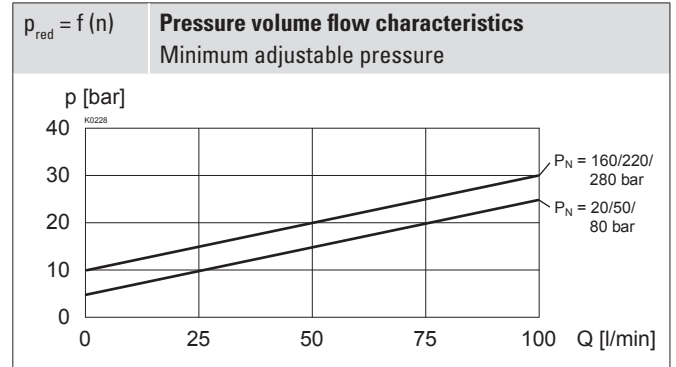
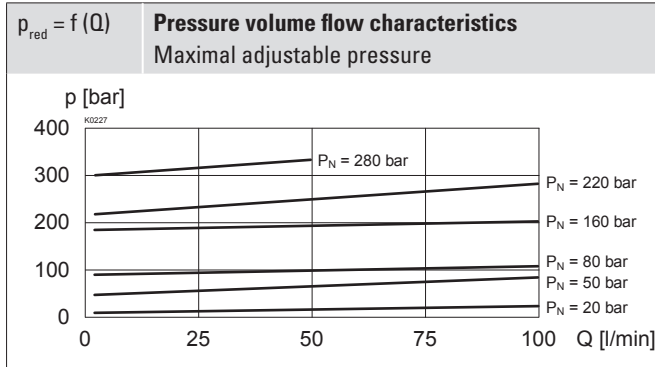

**PERFORMANCE SPECIFICATIONS EXECUTION L9 (MEASURED AT 40 °C)**

 Oil viscosity  $\nu = 30 \text{ mm}^2/\text{s}$ 

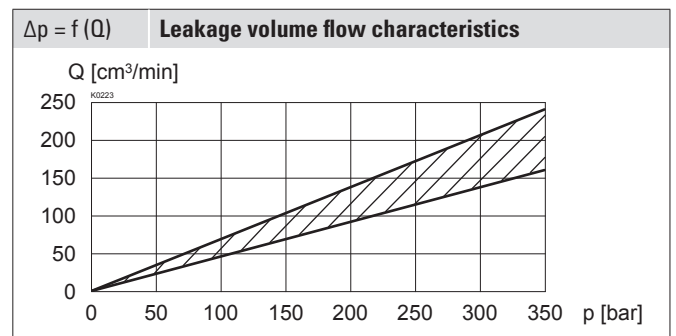
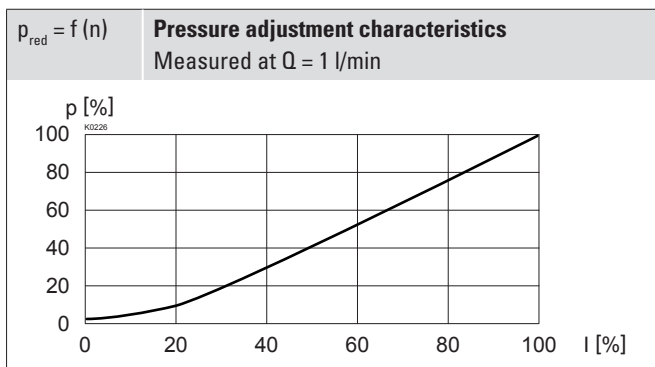
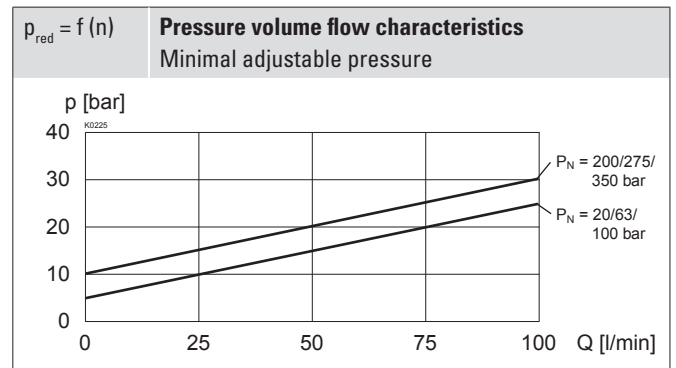
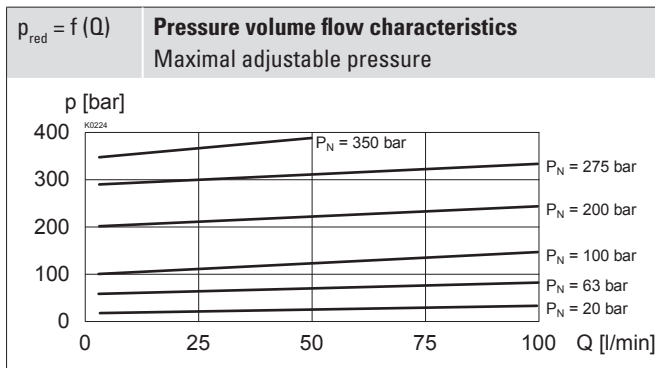
**PERFORMANCE SPECIFICATIONS EXECUTION L15 (MEASURED AT 50 °C)**

 Oil viscosity  $\nu = 30 \text{ mm}^2/\text{s}$ 

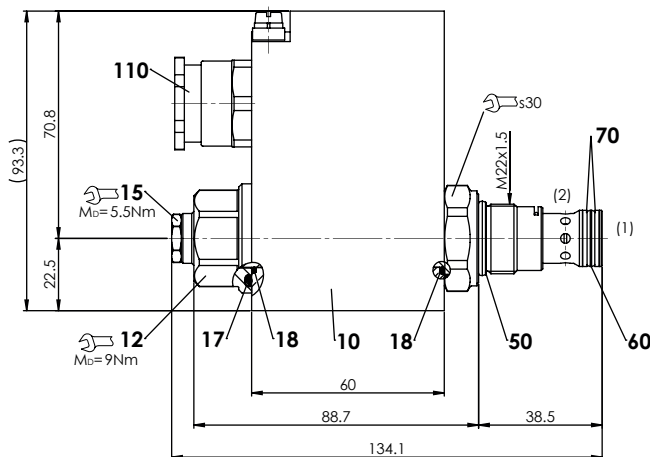
## DIMENSIONS



Dimensions of the solenoid coil see data sheet 1.1-183

## PARTS LIST

Position	Article	Description
10	263.6...	Solenoid coil MK.45 / 18 x 60
12	154.2603	Knurled nut Ex M18 x 1,5 x 18
15	253.8000	Manual override HB4,5
110	111.1080	Cable gland M20 x 1,5
	251.5920	Seal kit

### Seal kit consisting of:

17	O-ring	ID 25,07 x 2,62
18	O-ring	ID 17,17 x 1,78
50	O-ring	ID 18,77 x 1,78
60	O-ring	ID 14,00 x 1,78
70	B.up ring	PTFE rd 14,6 x 17,5 x 1,4

## STANDARDS

Cartridge cavity	ISO 7789
Explosion protection	Directive 2014 / 34 / EU (ATEX)
Flameproof enclosure	EN / IEC / UL 60079-1, 31
Cable entry	EN 60079-0, 1, 7, 15, 31
Protection class	EN 60 529
Contamination efficiency	ISO 4406

## INSTALLATION NOTES

Mounting type	Screw-in cartridge M22 x 1,5
Mounting position	Any, preferably horizontal
Tightening torque	$M_D = 60$ Nm Screw-in cartridge $M_D = 9$ Nm knurled nut $M_D = 9,5$ Nm HB0 $M_D = 5,5$ Nm HB4,5

**Attention!** For stack assembly please observe the remarks in the operating instructions



## HYDRAULIC CONNECTION

Cavity drawing according to ISO 7789-22-02-0-98

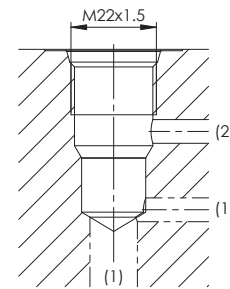

**Note!**



For detailed cavity drawing and cavity tools see data sheet 2.13-1003

## ACCESSORIES

Proportional amplifier	Register 1.13
Flange body / sandwich plate NG4-Mini	Data sheet 2.3-720
Flange body / sandwich plate NG6	Data sheet 2.3-740
Flange body / sandwich plate NG10	Data sheet 2.3-760
Threaded body	Data sheet 2.9-200
Technical explanations	Data sheet 1.0-100
Filtration	Data sheet 1.0-50

## MANUAL OVERRIDE

HB4,5 as standard

## SEALING MATERIAL

NBR or FKM (Viton) as standard, choice in the type code

## SURFACE TREATMENT

◆ The cartridge body, the slip-on coil and the armature tube are zinc-nickel coated

## COMMISSIONING

**Attention!** The solenoid coil must only be put into operation, if the requirements of the operating instructions supplied are observed to their full extent. In case of non-observance, no liability can be assumed.



Wandfluh AG Postfach CH-3714 Frutigen  
 Tel. +41 33 672 72 72 Fax +41 33 672 72 12 sales@wandfluh.com