

Quality products for
demanding applications

A large yellow mining truck is the central focus of the image, shown from a front-three-quarter perspective. It is parked on a dirt surface at what appears to be a quarry or mining site, with a large pile of dark rocks in the background. The truck has a prominent front grille with two large circular headlights, a metal railing around the front, and a large tire. The lighting is warm, suggesting late afternoon or early morning. The truck is the primary subject of the advertisement, representing the demanding applications mentioned in the text.

**PROPORTIONAL
MOBILE VALVES**

PROPORTIONAL **MOBILE VALVES**

The Proportional Mobile Valves (PMV) programme describes a flexible hydraulic concept that can be individually assembled and modularly adapted for any type of application. An internal pressure compensator is already integrated as standard which results in precise, load-independent and sensitive control.

PMV principally stands for a high degree of flexibility. Due to the modular design, PMV units can be designed and assembled for practically any type of application. The modules used are proportional spool valves with which the direction of movement and the speed of cylinders or hydraulic motors can be determined individually. Thanks to the built-in pressure compensator, the functions are controlled separately, continuously and at the same time load pressure compensated proportionally or via hand lever. Proportional spool valves PMV are suitable for all common pump systems. The volume flows and load pressures for the individual consumers can be set individually.



PROPERTIES

- Modular structure
- Individually adaptable
- Volume flows and load pressures can be individually adapted to the downstream consumers
- Extensive modular system with a multitude of variants and combination options
- Compact and lightweight design
- Robust and durable design for pressures up to 420 bar
- High energy efficiency due to low delta p
- Load Sensing Signal Amplifier
- Anti-saturation module
- Load-independent flow control
- Optionally with zinc/nickel coating
- Load sensing pressure relief valves for connections A and B allow reduced energy loss



AREAS OF APPLICATION

High power density and reliability under all working conditions have always been important requirements for the use in the mobile sector. In order to carry out heavy work with large machines efficiently and yet also precisely, hydraulics that are well-adapted to the machine are required. With the highly flexible assemblable PMV programme, these units can be used almost everywhere in mobile applications. The PMV is optionally available in a zinc/nickel coating for high corrosion resistance.

The areas of application are very diverse. PMV are used where very compact installation dimensions are required and a function must be sensitively controlled.

Typical applications are cylinder and motor controls for all handling functions in such as:

- Working boats
- Fishery equipment
- Loading cranes
- Telescopic handlers
- Aerial platforms
- Municipal vehicles
- Construction machinery
- Drilling equipment
- Agricultural and forestry machinery
- Offshore applications
- Underground mining

Most applications are remotely controlled with the proportional valve. However, due to the modular design, hydraulic joysticks can also directly control the valves or the functions can be controlled with built-in hand lever actuators. The PMV units are the ideal choice for compact and efficient hydraulic systems on the high seas or in harbour facilities.



THE PMV CONCEPT

The PMV concept allows an individual composition of single modules, which are available as pre-assembled units with their own type code. Modifications can also be carried out quickly in the field.

Due to the modular design, special solutions can be created in a flexible manner as well. For example, counterbalance valves integrated in the connection plate or operated non-return valves can be integrated. There are two nominal sizes available: PMV-16 and PMV-22.

The individual PMV modules in nominal sizes 16 and 22 are divided as follows:

- Inlet plate PMV-B16 PMV-B22
- Control section PMV-M16 PMV-M22
- Spool PMV-S16 PMV-S22

- Control module
 - Electrical-proportional PMV-P16 PMV-P22
 - Hydraulic PMV-H16 PMV-H22
 - End cap PMV-A16 PMV-A22
- Spring cap PMV-D16 PMV-D22
- Manual actuation PMV-L16 PMV-L22
- Connection plate PMV-C16 PMV-C22
- End plate PMV-E16 PMV-E22
- Twin connection plate – PMV-C22-T
- Reduction plate 22/16 – PMV-R22

A-SIDE

B-SIDE

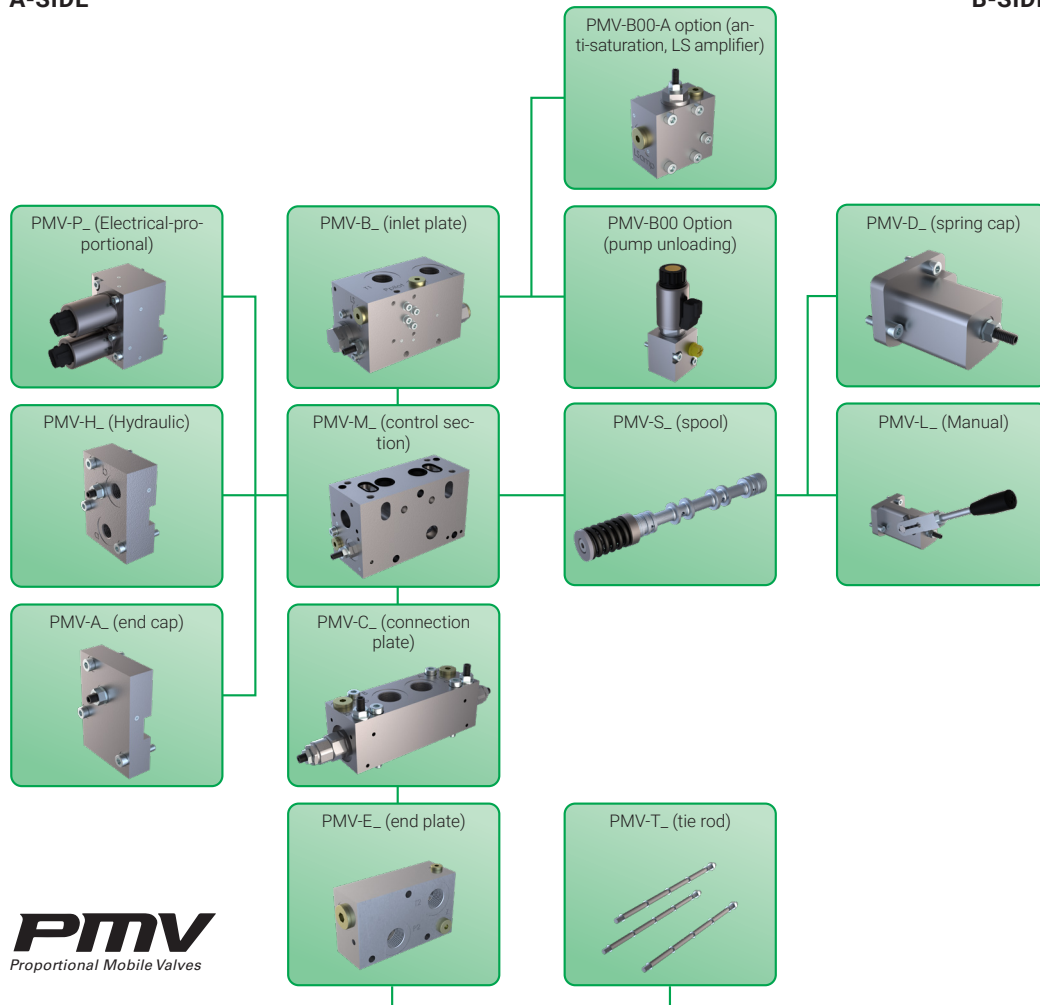

INLET AND END PLATE

The inlet plate of the PMV can be configured for all common pump types. Inlet plates are available for variable displacement pumps, fixed displacement pumps and constant pressure systems.

The inlet plates have a maximum pressure setting for the entire valve block. Various unloading functions, an electrical-proportional pressure adjustment, an LS signal amplifier and an anti-saturation function can be configured as special functions. If insufficient pump flow is provided to the valve block, then the anti-saturation function reduces the feed pressure of the pilot circuit.

This enables the simultaneous and load pressure independent operation of the individual functions. The LS amplifier option amplifies the LS signal in the direction of the pump and compensates for signal losses.

The end plate can be optionally designed with extra P and T connections or with preparation for serial connection of the pressure transmission ("Power Beyond").

INLET PLATE

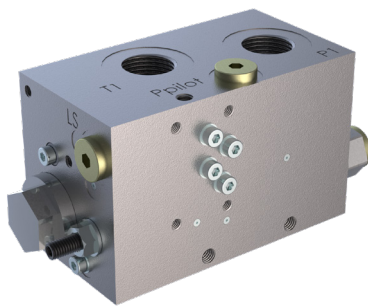

B_

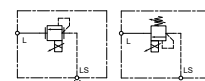
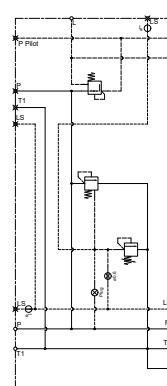

Electrical-proportional pressure relief option

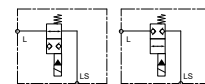

Unloading option

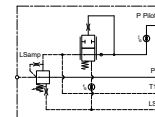

Anti-saturation, LS amplifier

END PLATE

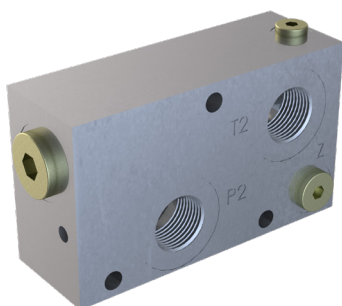

E_



CONTROL SECTION

The control section is modularly built on the standard of a basic control unit. It is equipped with a control spool that is precisely adjusted to the function and already includes a 2-way pressure compensator in the standard version to automatically compensate internally for any load changes in the system. This pressure compensator is available with or without non-return valve function, as required.

In addition to electric or hydraulic actuation, pure manual actuation or a manual override is also available as a control section. The PMV modular system can be combined in any desired way and can be configured with up to 12 control sections. For this purpose, the corresponding tie rods are avail-

able for easy assembly. The use of diverse connection plates enables a variety of required consumer functions. Based on the modular principle, the "Build Programme" provides the required operating form as a control module.

CONNECTION PLATES C_

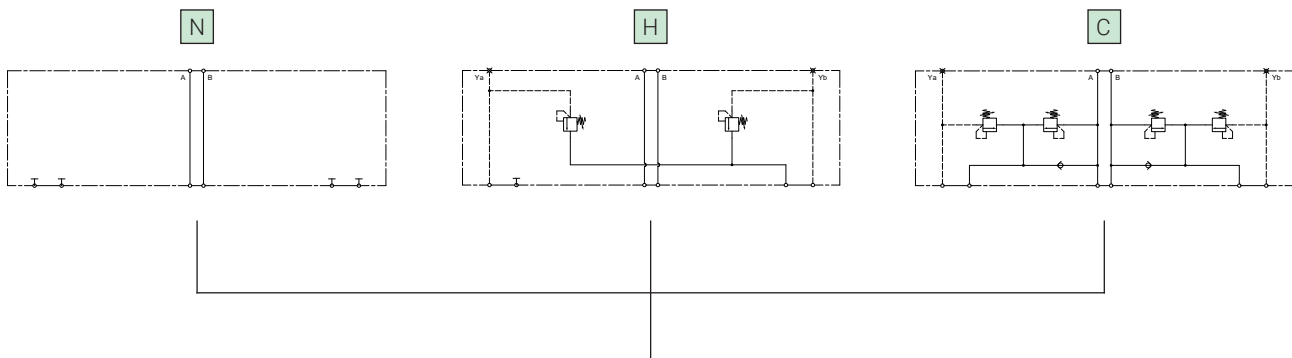
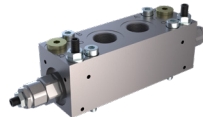

CONTROL SECTION M_

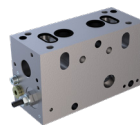

Manual actuation

Electrically-proportionally actuated

Hydraulically actuated

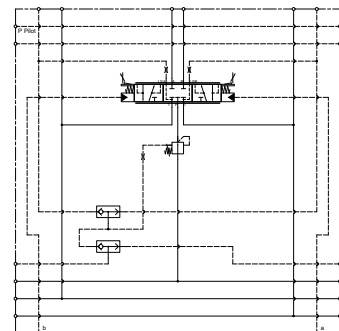
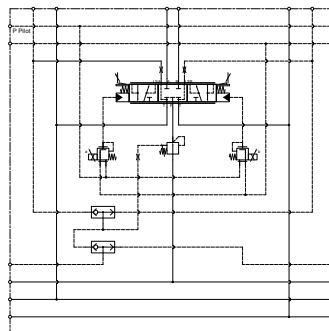
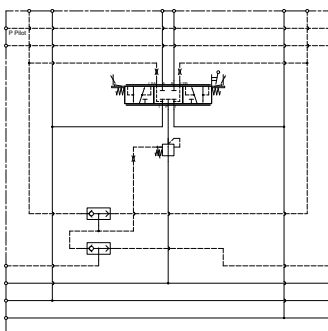

REDUCTION AND TWIN PLATE

Two additional special plates are available for the nominal size PMV-22. The reduction plate was developed for the combination of nominal sizes 22 and 16. A twin plate is a special connection plate of the NG22 for connecting two M22 control sections.

The reduction plate has the same design as a standard inlet plate. However, the M22 control sections are attached to one face, the M16 sections to the other.

This inlet plate has a maximum pressure setting for the entire valve block. Various unloading functions, an LS signal ampli-

fier, an anti-saturation function and an electrical-proportional pressure adjustment can be configured as special functions.

The twin plate is used to connect two M22 control sections. This allows twice the flow rate to the consumer to be achieved. However, it can also be used as a fast and fine feed function.

REDUCTION PLATE 22 / 16

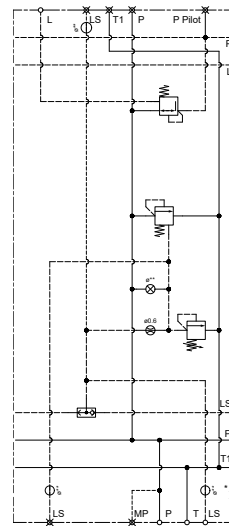
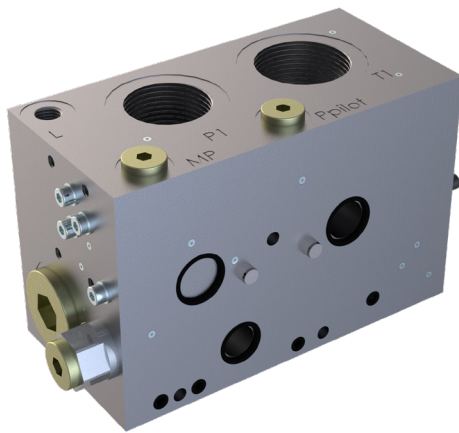

TWIN CONNECTION PLATE

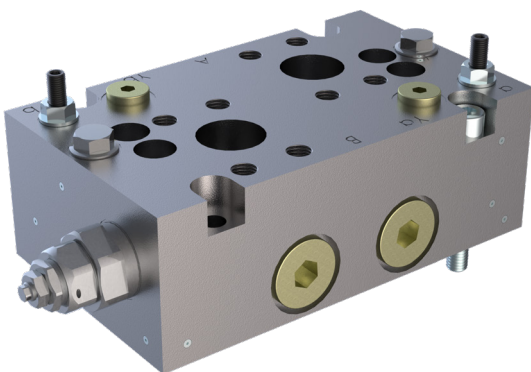

PMV-16 DIMENSIONS AND DIAGRAM

The PMV-16 control unit offers a convincing combination of high power density and optimum use of space. The example control unit shows the individual functions in detail and the optimal arrangement of the components. This ensures that the hoses, electrical connections and manual operation are routed locally separately.

DIAGRAM OF AN EXAMPLE PMV-16 CONTROL UNIT

This unit consists of an inlet plate, four control sections and an end plate, which are assembled together with tie rods. Via the various connection blocks, the control sections are hydraulically connected to the hydraulic cylinders and motors in

the system. The inlet plate contains all important control elements and in the control sections the elements are precisely adjusted to the function to guarantee optimum parameterisation of the pressures and flows.

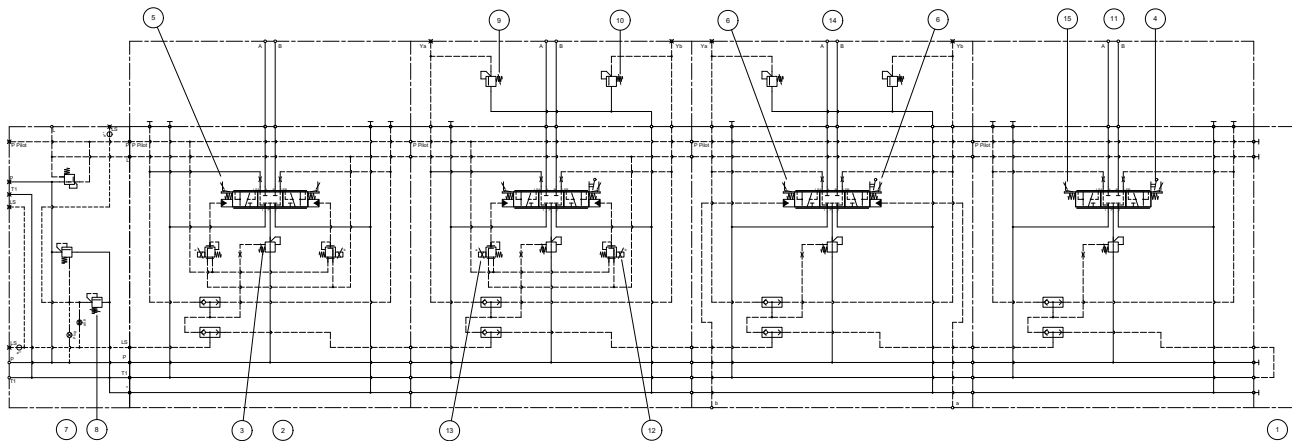

DIMENSION DRAWING

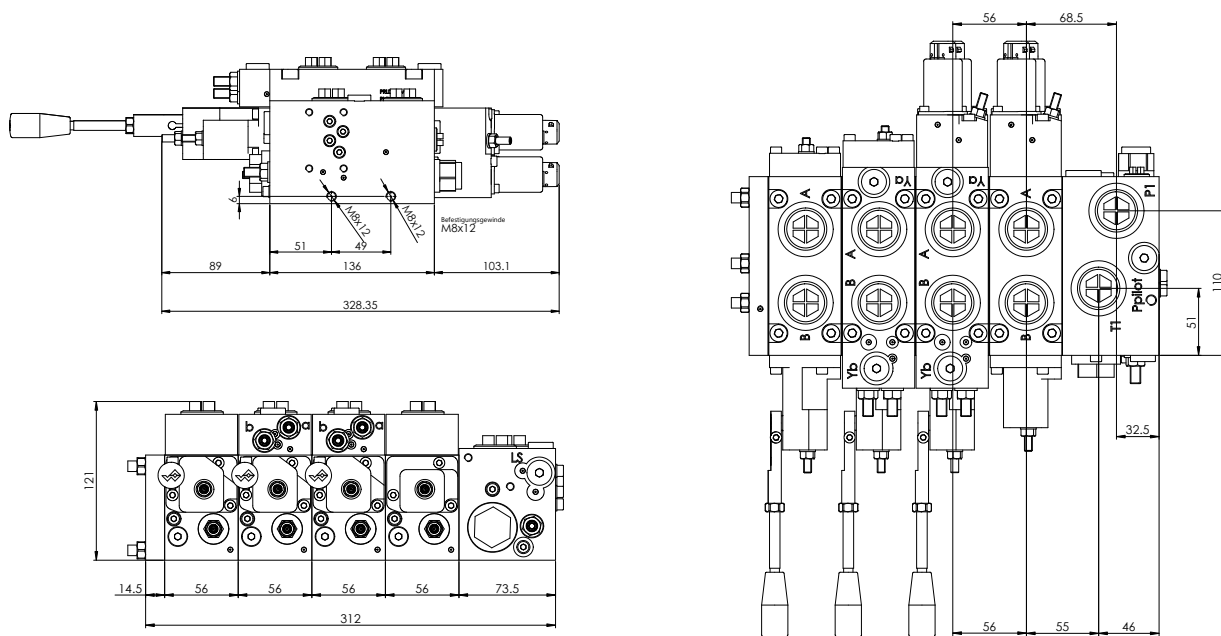

PMV-22 DIMENSIONS AND DIAGRAM

The PMV-22 control unit offers persuasively high flow rates of up to 400 l/min in the consumer alongside the smallest possible dimensions. Like the nominal size 16, the nominal size 22 is configured for maximum pressures of 420 bar. The example control unit shows the individual functions in detail and the optimal arrangement of the components. This ensures that the hosing, electrical connections and manual operation are routed locally separately.

DIAGRAM OF AN EXAMPLE PMV-22 CONTROL UNIT

This unit consists of an inlet plate, four control sections and an end plate, which are assembled together with tie rods. Via the various connection blocks, the control sections are hydraulically connected to the hydraulic cylinders and motors in

the system. The inlet plate contains all important control elements and in the control sections the elements are precisely adjusted to the function to guarantee optimum parameterisation of the pressures and flows.

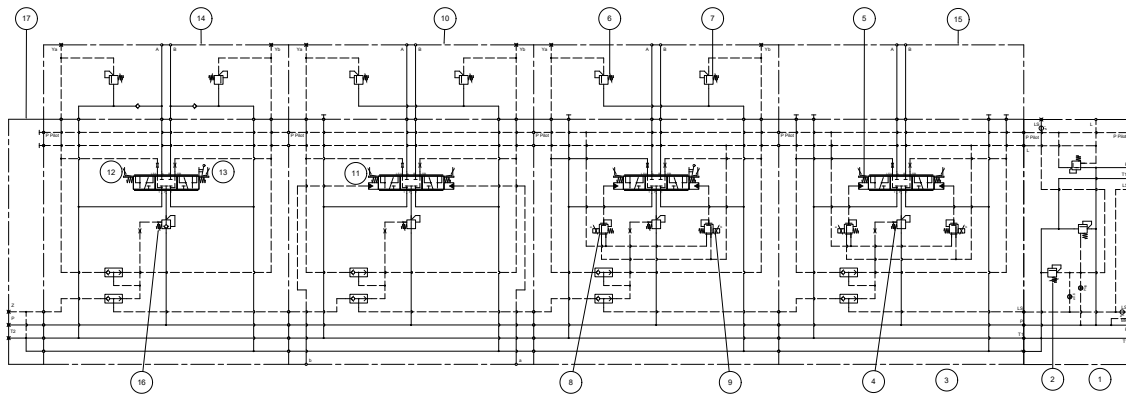

DIMENSION DRAWING

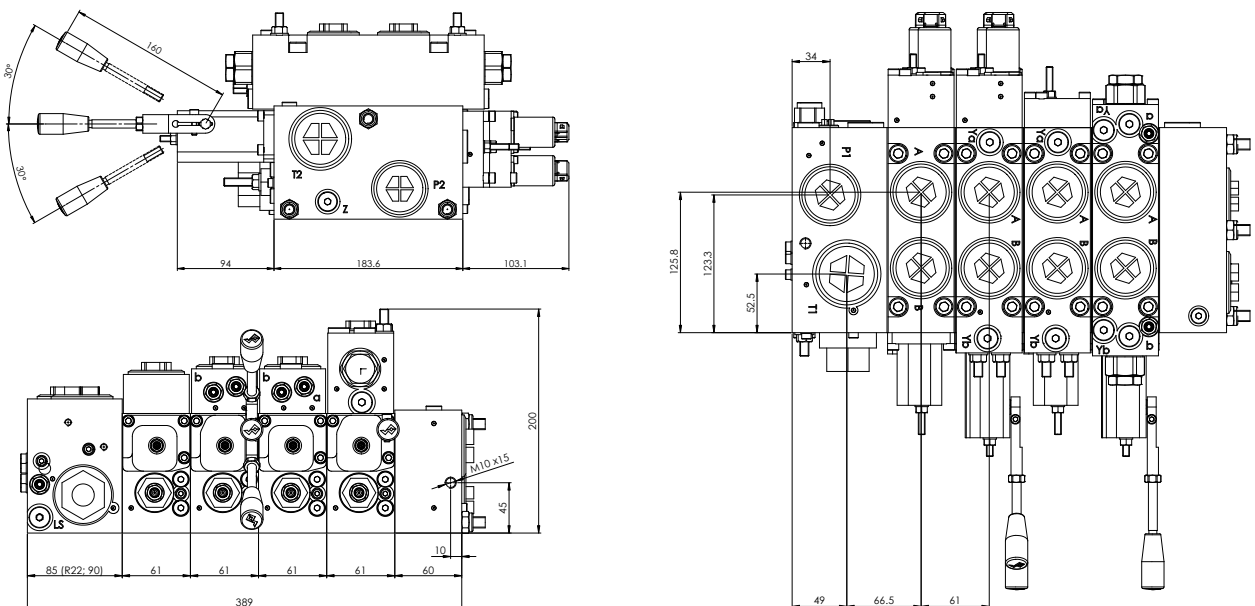

PMV-22/16 COMBINATION

The PMV-R22 reduction plate makes it very easy to combine the PMV-22 and PMV-16, ensuring that the unit is adapted to the necessary consumers yet at the same time is very compact. The combination unit carries all the benefits of the different nominal sizes and is the perfect solution for many applications. The twin plate combination even allows a flow rate of almost 800 l/min to be set in the consumer.

DIAGRAM OF AN EXAMPLE PMV-22 WITH PMV-16 COMBINATION CONTROL UNIT

Instead of a standard inlet plate, this version uses the PMV-R22 reduction plate with the M22 sections attached on one side and the M16 sections on the other. The functions are completed and connected on both the left and the right of the units with an end plate and the corresponding tie rods. In this diagram the first two M22 control sections are connected to

the consumer by means of a common connection plate. This version allows flow rates of up to almost 800 l/min to be adjusted sensitively. Alternatively, a fine/fast feed control can be achieved with these two sections by installing a smaller flow spool in one of the sections.

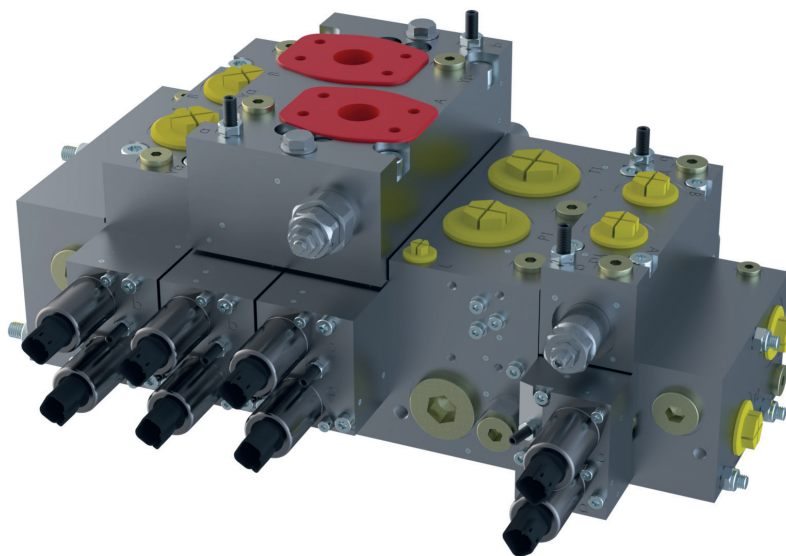
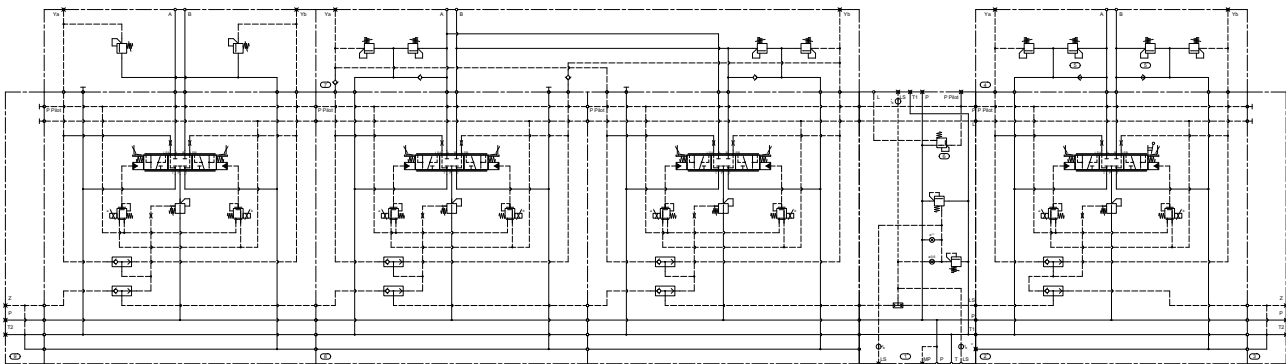

PMV-22/16 PERFORMANCE DATA

The PMV control units offer a convincing combination of high power density and optimum use of space. All control sections with pressure compensation ensure a stable flow rate across the entire pressure range. The optimum use of the PMV-16 and PMV-22 allows an extremely large range of applications to be covered, with flow rates in the consumer ranging from a few litres a minute to almost 800 l/min.

SPECIFICATIONS	PMV-16	PMV-22
Max. pressure	420 bar	420 bar
Max. inlet flow rate	260 l/min	800 l/min
Flow rate per section @10bar Flow rate per section @17bar	100 l/min 120 l/min	260 l/min 350 l/min
Max. flow rate per section (without pressure compensation)	180 l/min (200 l/min)	400 l/min (450 l/min)
Option	Zinc-nickel coating	Zinc-nickel coating
2 control sections parallel via twin plate, Q_{max} in A and B	–	690–800 l/min
Port connection A, B	G3/4"	G1¼"
Port connection P, T (2x each)	G3/4"	P: G1¼" T: G1½"
Twin plate connection	–	SAE flange 1", code 62 (6000psi)
Amplifier, anti-saturation option	Yes	Yes
Pump unloading option	On/off and proportional	On/off and proportional
Max. number of sections	12	10

PMV-M16

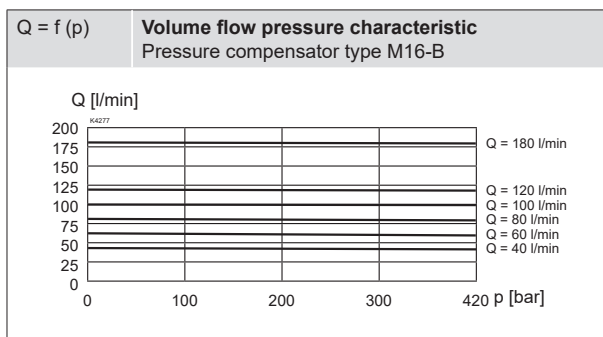

PMV-M22

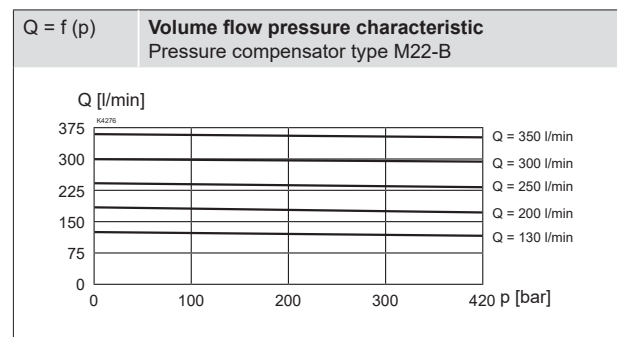

SWITZERLAND

Wandfluh AG
Division PMV

Helkenstrasse 13
3714 Frutigen
Phone +41 33 672 72 72
Fax +41 33 672 72 82
sales@wandfluh.com
www.wandfluh.com



PMV
Proportional Mobile Valves

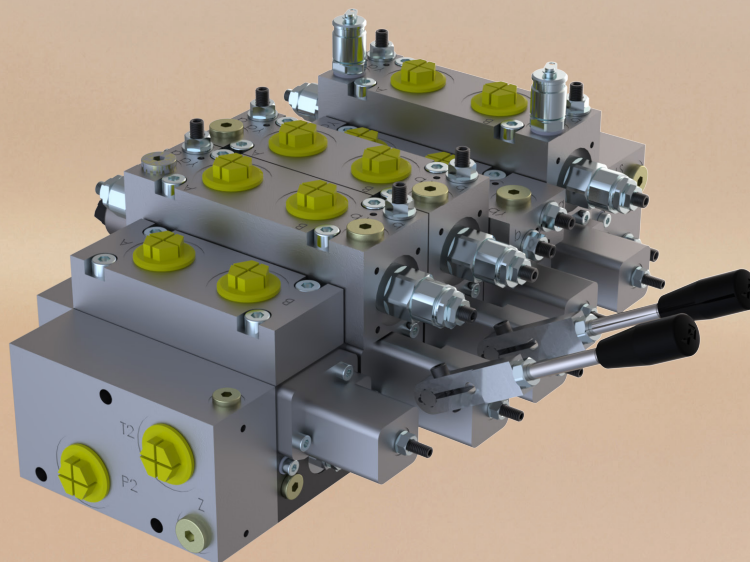

SOLUTIONS **SINCE 1946**

ID4222D