

STEP BY STEP

INSTRUCTION

SD7 - ELECTRONICS

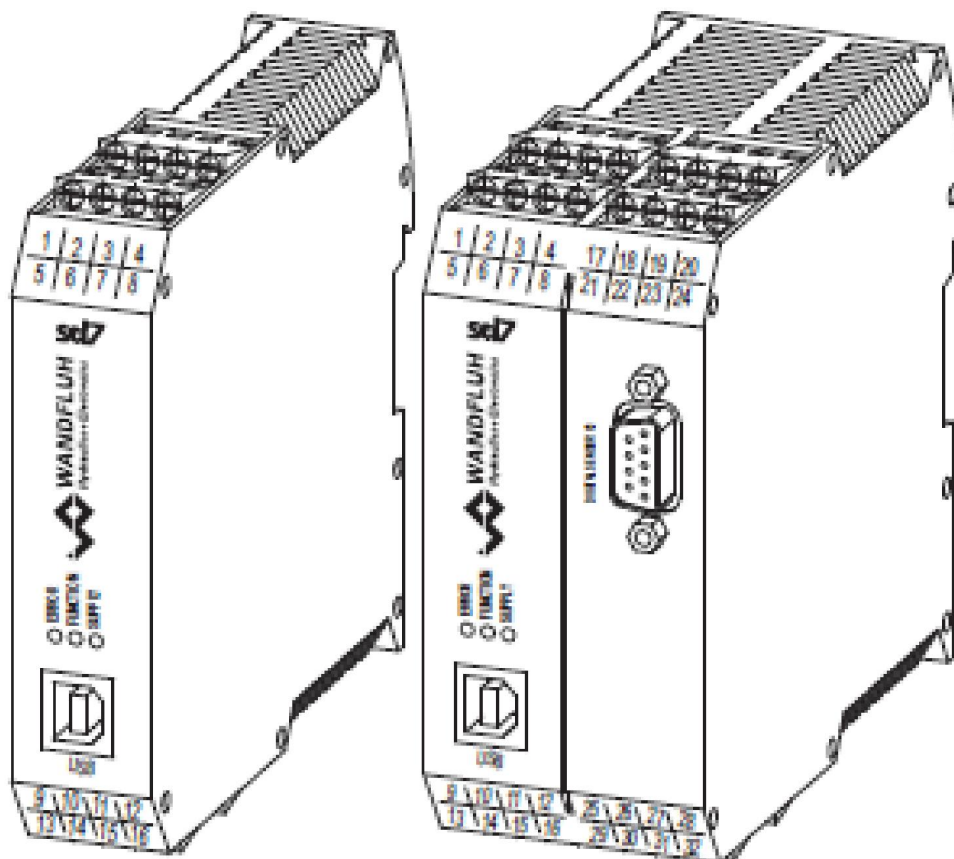

Contents

1	General Information	5
2	Setup Instruction 1-solenoid valve open loop	6
2.1	Introduction.....	6
2.2	Activate PASO Off Line mode.....	7
2.3	Select controller mode (only with a SD7 controller).....	7
2.4	Select valve type.....	7
2.5	Scale command signal.....	8
2.6	Set command values fixed (optional).....	8
2.7	Set ramp generator (optional).....	9
2.8	Set solenoid driver 1.....	9
2.9	Set error evaluation (optional).....	9
2.10	Set function (optional).....	9
2.11	Set analog output (optional, only possible with the Enhanced version).....	10
2.12	Set enable channel.....	10
2.13	Save parameters in a file (optional).....	11
2.14	Activate PASO On Line mode.....	12
3	Setup Instruction 2-solenoid valve open loop	13
3.1	Introduction.....	13
3.2	Activate PASO Off Line mode.....	14
3.3	Select controller mode.....	14
3.4	Select valve type.....	14
3.5	Scale command signal.....	15
3.6	Set command values fixed.....	15
3.7	Set ramp generator (optional).....	16
3.8	Set solenoid driver 1.....	16
3.9	Set solenoid driver 2.....	16
3.10	Set error evaluation (optional).....	17
3.11	Set function (optional).....	17
3.12	Set analog output (optional, only possible with the Enhanced version).....	17
3.13	Set enable channel.....	17
3.14	Save parameters in a file (optional).....	18
3.15	Activate PASO On Line mode.....	19
4	Setup Instruction Pressure/flow valve closed loop (1-sol)	20
4.1	Introduction.....	20
4.2	Activate PASO Off Line mode.....	22
4.3	Select controller mode.....	22
4.4	Select valve type.....	22
4.5	Scale command signal.....	22
4.6	Scale feedback signal.....	23
4.7	Set command values fixed (optional).....	23
4.8	Set speed.....	24
4.9	Set manual operation (optional).....	24
4.10	Set windows.....	24
4.11	Set controller.....	25
4.12	Set solenoid driver 1.....	25
4.13	Set error evaluation (optional).....	26
4.14	Set function (optional).....	26
4.15	Set analog output (optional, only possible with the Enhanced version).....	26
4.16	Set enable channel.....	26
4.17	Save parameters in a file.....	27
4.18	Activate PASO On Line mode.....	28
5	Setup Instruction Pressure control closed loop (2-sol)	29
5.1	Introduction.....	29
5.2	Activate PASO Off Line mode.....	31
5.3	Select controller mode.....	31
5.4	Select valve type.....	31
5.5	Scale command signal.....	31
5.6	Scale feedback signal.....	32
5.7	Set command values fixed (optional).....	32
5.8	Set speed.....	33
5.9	Set manual operation (optional).....	33
5.10	Set windows.....	33

5.11	Set controller.....	34
5.12	Set solenoid driver 1.....	34
5.13	Set solenoid driver 2.....	35
5.14	Set error evaluation (optional).....	35
5.15	Set function (optional).....	35
5.16	Set analog output (optional, only possible with the Enhanced version).....	35
5.17	Set enable channel.....	36
5.18	Save parameters in a file (optional).....	37
5.19	Activate PASO On Line mode.....	38
6	Setup Instruction Position closed loop (2-sol)	39
6.1	Introduction.....	39
6.2	Activate PASO Off Line mode.....	41
6.3	Select controller mode.....	41
6.4	Select valve type.....	41
6.5	Scale command signal.....	41
6.6	Scale feedback signal.....	42
6.7	Set command values fixed (optional).....	42
6.8	Set speed.....	43
6.9	Set manual operation (optional).....	43
6.10	Set windows.....	43
6.11	Set controller.....	44
6.12	Set solenoid driver 1.....	44
6.13	Set solenoid driver 2.....	45
6.14	Set error evaluation (optional).....	45
6.15	Set function (optional).....	45
6.16	Set analog output (optional, only possible with the Enhanced version).....	45
6.17	Set enable channel.....	46
6.18	Save parameters in a file (optional).....	47
6.19	Activate PASO On Line mode.....	48
7	Setup Instruction Speed control closed loop (2-sol)	49
7.1	Introduction.....	49
7.2	Activate PASO Off Line mode.....	51
7.3	Select controller mode.....	51
7.4	Select valve type.....	51
7.5	Scale command signal.....	51
7.6	Scale feedback signal.....	52
7.7	Set command values fixed (optional).....	52
7.8	Set speed.....	53
7.9	Set manual operation (optional).....	53
7.10	Set windows.....	53
7.11	Set controller.....	54
7.12	Set solenoid driver 1.....	54
7.13	Set solenoid driver 2.....	55
7.14	Set error evaluation (optional).....	55
7.15	Set function (optional).....	55
7.16	Set analog output (optional, only possible with the Enhanced version).....	55
7.17	Set enable channel.....	56
7.18	Save parameters in a file (optional).....	57
7.19	Activate PASO On Line mode.....	58
8	Setup Instruction 2-point controller (1-sol)	59
8.1	Introduction.....	59
8.2	Activate PASO Off Line mode.....	61
8.3	Select controller mode.....	61
8.4	Select valve type.....	61
8.5	Scale command signal.....	61
8.6	Scale feedback signal.....	62
8.7	Set command values fixed (optional).....	62
8.8	Set speed.....	63
8.9	Set manual operation (optional).....	63
8.10	Set windows.....	63
8.11	Set controller.....	64
8.12	Set solenoid driver 1.....	64
8.13	Set error evaluation (optional).....	64
8.14	Set function (optional).....	65
8.15	Set analog output (optional, only possible with the Enhanced version).....	65

8.16	Set enable channel.....	65
8.17	Save parameters in a file (optional).....	66
8.18	Activate PASO On Line mode.....	67
9	Setup Instruction 2-point controller (2-sol)	68
9.1	Introduction.....	68
9.2	Activate PASO Off Line mode.....	70
9.3	Select controller mode.....	70
9.4	Select valve type.....	70
9.5	Scale command signal.....	70
9.6	Scale feedback signal.....	71
9.7	Set command values fixed (optional).....	71
9.8	Set speed.....	72
9.9	Set manual operation (optional).....	72
9.10	Set windows.....	72
9.11	Set controller.....	73
9.12	Set solenoid driver 1.....	73
9.13	Set solenoid driver 2.....	74
9.14	Set error evaluation (optional).....	74
9.15	Set function (optional).....	74
9.16	Set analog output (optional, only possible with the Enhanced version).....	74
9.17	Set enable channel.....	74
9.18	Save parameters in a file (optional).....	76
9.19	Activate PASO On Line mode.....	77
10	Setup Instruction 3-point controller (2-sol)	78
10.1	Introduction.....	78
10.2	Activate PASO Off Line mode.....	80
10.3	Select controller mode.....	80
10.4	Select valve type.....	80
10.5	Scale command signal.....	80
10.6	Scale feedback signal.....	81
10.7	Set command values fixed (optional).....	81
10.8	Set speed.....	82
10.9	Set manual operation (optional).....	82
10.10	Set windows.....	82
10.11	Set controller.....	83
10.12	Set solenoid driver 1.....	83
10.13	Set solenoid driver 2.....	84
10.14	Set error evaluation (optional).....	84
10.15	Set function (optional).....	84
10.16	Set analog output (optional, only possible with the Enhanced version).....	84
10.17	Set enable channel.....	84
10.18	Save parameters in a file (optional).....	86
10.19	Activate PASO On Line mode.....	87

1 General Information

This step by step guide is designed to provide the user with a simple alignment. It contains for any amplifier or controller type an instruction which describes the required parameters in the correct order.

For a detailed description of the hardware, a product description and a description of all parameters, please refer to "Operating instructions to Amplifier Electronics SD7" resp. "Operating instructions to Controller Electronics SD7".

Note: Please read in advance the appropriate operating instruction.

2 Setup Instruction 1-solenoid valve open loop

2.1 Introduction

This guide shows with an example how to set the SD7 Electronics for controlling a 3/2-way proportional valve in an open loop control (without a feedback signal) for controlling a hydraulic motor with one directions.

Pretended:

Controller mode: Spool valve open loop
 Command signal: 0 ... 10V at the analog input 1
 Mode of operation: 0 ... 10V command value for solenoid A
 Valve connection: 3/2-way proportional valve at solenoid A
 Enable channel: external via digital input 1

The following steps are necessary (steps with the remark "optional" are only necessary if needed):

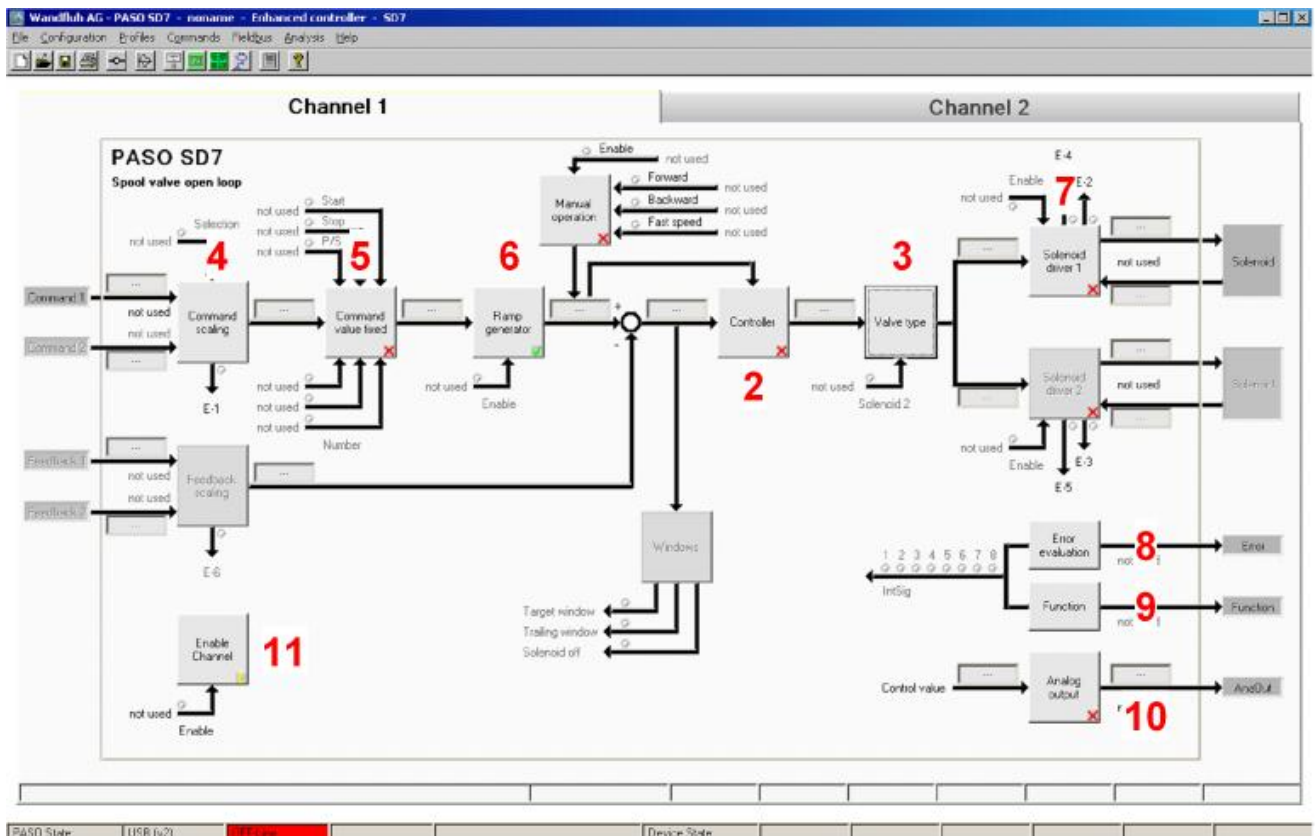

1. [Activate PASO Off Line mode](#) ^[7]
2. [Select controller mode](#) ^[7] (only with a SD7 controller)
3. [Select valve type](#) ^[7]
4. [Scale command signal](#) ^[8]
5. [Set command values fixed](#) ^[8] (optional)
6. [Set ramp generator](#) ^[9] (optional)
7. [Set solenoid driver 1](#) ^[9]
8. [Set error evaluation](#) ^[9] (optional)
9. [Set function](#) ^[9] (optional)
10. [Set analog output](#) ^[10] (optional, only possible with the Enhanced version)
11. [Set enable channel](#) ^[10]
12. [Save parameters in a file](#) ^[11] (optional)
13. [Activate PASO On Line mode](#) ^[12]
14. By activating the digital input 1, the channel 1 will be released in the controller mode "Pressure/flow valve open loop"

2.2 Activate PASO Off Line mode

Select "File - Activate Off Line"

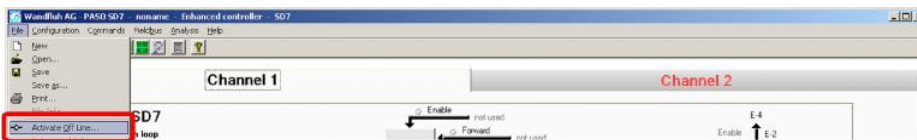

Select "OK"



In the status line the message "Off-Line" appears



2.3 Select controller mode (only with a SD7 controller)

Parameter	Description
Controller mode	Select controller mode "Position open loop"

All other parameters in this window will be set later.

2.4 Select valve type

Parameter	Description
Mode of operation	Select the corresponding mode of operation (in the example "Command unipolar (1-sol)")
Solenoid type	Select the solenoid type of the connected valve (in the example "Proportional solenoid with current measurement")
Valve type	Select the valve type of the connected valve (in the example "Standard 2-solenoid")

The remaining parameters have no function in this control mode

2.5 Scale command signal

Command value 1

Parameter	Description
Signal type	Set the signal type from the command signal generator (in the example "Voltage")
Used analog input	If the parameter "Signal type" is set to "Voltage" or "Current", the input where the command signal generator is connect can be selected here (in the example "AnalIn1 [V]")
Used digital input	If the parameter "Signal type" is set to "Digital", "Frequency" or "PWM", the input where the command signal generator is connect can be selected here
Cablebreak detection	If the parameter "Signal type" is set to "Current", "Frequency" or "PWM", a cablebreak detection of the command signal generator can be activated
Lower cablebreak limit	If the parameter "Cablebreak detection" is set to "yes", the lower limit of this detection can be set here (command value < lower cablebreak limit = cablebreak)
Upper cablebreak limit	If the parameter "Cablebreak detection" is set to "yes", the upper limit of this detection can be set here (command value > upper cablebreak limit = cablebreak)
min interface	Set the minimum command signal level (in the example 0V)
max interface	Set the maximum command signal level (in the example 10V)
min Reference	Set the minimum desired scaled command value (correspond to the command value at "min interface", in the example 0%)
max Reference	Set the maximum desired scaled command value (correspond to the command value at "max interface", in the example 100%)
Function	Set the desired function for the second command signal input (in the example "not used")

General

Deadband function	Enable the deadband function
Deadband threshold	If the parameter "Deadband function" is set to "on", the threshold for the deadband can be set here (command value < deadband threshold => solenoid output = 0)

2.6 Set command values fixed (optional)

Parameter	Description
Enable	Enable the fixed command value function
Selection 1	Set the desired digital input for the fixed command value 1
Selection 2	Set the desired digital input for the fixed command value 2 and 3
Selection 4	Set the desired digital input for the fixed command value 4, 5, 6 and 7
Fixed command value 1	Set the desired command value for the fixed command value 1. This value becomes the active command value if the digital input from "Selection 1" is activated
Fixed command value 2	Set the desired command value for the fixed command value 2. This value becomes the active command value if the digital input from "Selection 2" is activated
Fixed command value 3	Set the desired command value for the fixed command value 3. This value becomes the active command value if the digital input from "Selection 1" and "Selection 2" are activated together
Fixed command value 4	Set the desired command value for the fixed command value 4. This value becomes the active command value if the digital input from "Selection 3" is activated
Fixed command value 5	Set the desired command value for the fixed command value 5. This value becomes the active command value if the digital input from "Selection 1" and "Selection 4" are activated together
Fixed command value 6	Set the desired command value for the fixed command value 6. This value becomes the active command value if the digital input from "Selection 2" and "Selection 4" are activated together

Fixed command value 7	Set the desired command value for the fixed command value 7. This value becomes the active command value if the digital input from "Selection 1", "Selection 2" and "Selection 4" are activated together
-----------------------	--

2.7 Set ramp generator (optional)

Parameter	Description
Enable	Enable the ramp generator function
Ramp positive up	Ramptime for the current increase on solenoid driver 1
Ramp positive down	Ramptime for the current decrease on solenoid driver 1

2.8 Set solenoid driver 1

Parameter	Description
Solenoid output	Select the output, where the solenoid is connected (in the example "SolOutA")
Enable	Selection, if the solenoid output is constantly enabled (selection "on"), constantly disabled (selection "off") or if it depends on a digital input (selection "external")
Dig. input	If the parameter "Enable" is set to "external", the corresponding digital input can be selected here
Inversion	If a solenoid with a inverse function is used, this selection should be "yes", otherwise "no"
Solenoid always active	In this control mode, this parameter must always be set to "no"
Cablebreak detection	If the cablebreak detection for the solenoid output is desired, this selection should be "yes", otherwise "no"
Characteristic optimisation	If the characteristic optimisation is desired, this selection should be "yes", otherwise "no". (the settings for the characteristic optimisation is made in the Tab-window "Characteristic optimisation")
Imin	Set the desired minimum current for solenoid A (correspond to the current at 0% command signal)
Imax	Set the desired maximum current for solenoid A (correspond to the current at 100% command signal)
Dither function	The dither function should be activated (Selection "on")
Dither frequency	Set the desired dither frequency value
Dither level	Set the desired dither level value

The remaining parameters have no function in this control mode

2.9 Set error evaluation (optional)

Parameter	Description
Selection	Here one can choose what error should activate the selected digital output
Dig. output	As soon as one of the selected error occurs, the selected digital output will be activated
Error action	With error "Cablebreak command signal" , the desired error action can be set. The default setting is "Solenoid 1 + 2 off"

2.10 Set function (optional)

Parameter	Description
Selection	Here one can choose what function should activate the selected digital output

2.11 Set analog output (optional, only possible with the Enhanced version)

Parameter	Description
Signal	Select the desired signal which is to be performed on the analog output
Used output	Select the output, at which the desired signal is to be performed
min reference	Set the minimum signal level
max reference	Set the maximum signal level
min interface	Set the minimum desired output signal level (correspond to the output signal level at "min Interface")
max interface	Set the maximum desired output signal level (correspond to the output signal level at "max Interface")

2.12 Set enable channel

Parameter	Description
Enable	Selection, if the channel is constantly enabled (selection "on"), constantly disabled (selection "off") or if it depends on a digital input (selection "external")
Dig. input	If the parameter "Enable" is set to *external", the corresponding digital input can be selected here (in the example "DigInp1")

2.13 Save parameters in a file (optional)

Select "File - Save as ..."



Enter the directory and file name, afterwards select "OK"

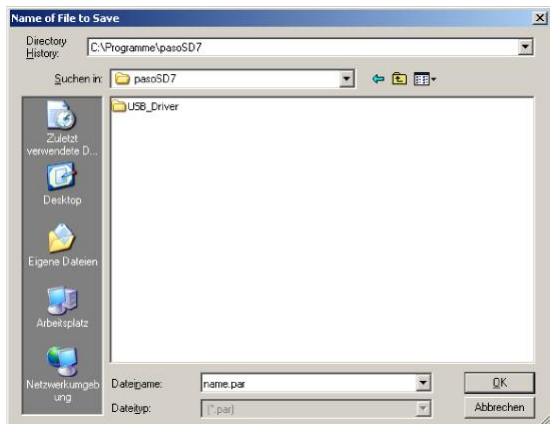

If required, enter the corresponding values to "Operator" and "Remarks", afterwards select "OK"

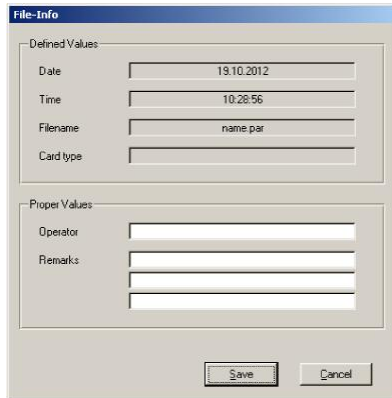

In the header line the corresponding file name appears

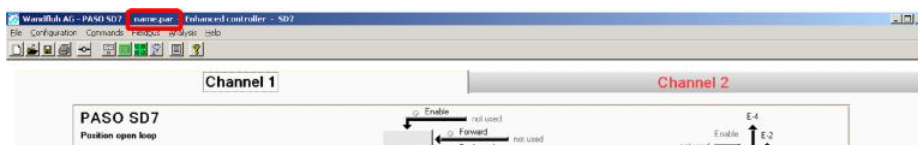

2.14 Activate PASO On Line mode

Select "File - Activate On Line"



Select "Program the Wandfluh-Electronic with the new actual data?"

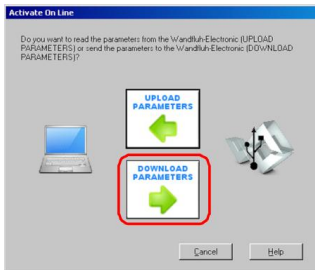

Select "OK"

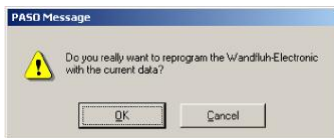

Select "OK"

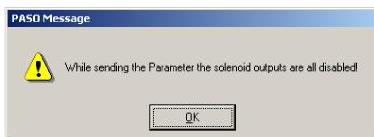

Wait, until all parameters are sent to the MD2 Electronics

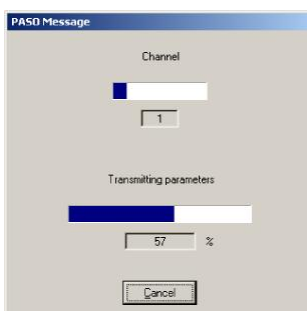

In the status line the message "On-Line" appears



3 Setup Instruction 2-solenoid valve open loop

3.1 Introduction

This guide shows with an example how to set the SD7 Electronics for controlling a 4/3-way proportional valve in an open loop control (without a feedback signal) for controlling a hydraulic motor with two directions.

Pretended:

Controller mode: Position open loop
 Command signal: 0 ... 10V at the analog input 1
 Mode of operation: 0 ... 5V command value for solenoid B, 5 ... 10V command value for solenoid A
 Valve connection: 4/3-way proportional valve, solenoid A = direction right, solenoid B = direction left
 Enable channel: external via digital input 1

The following steps are necessary (steps with the remark "optional" are only necessary if needed):

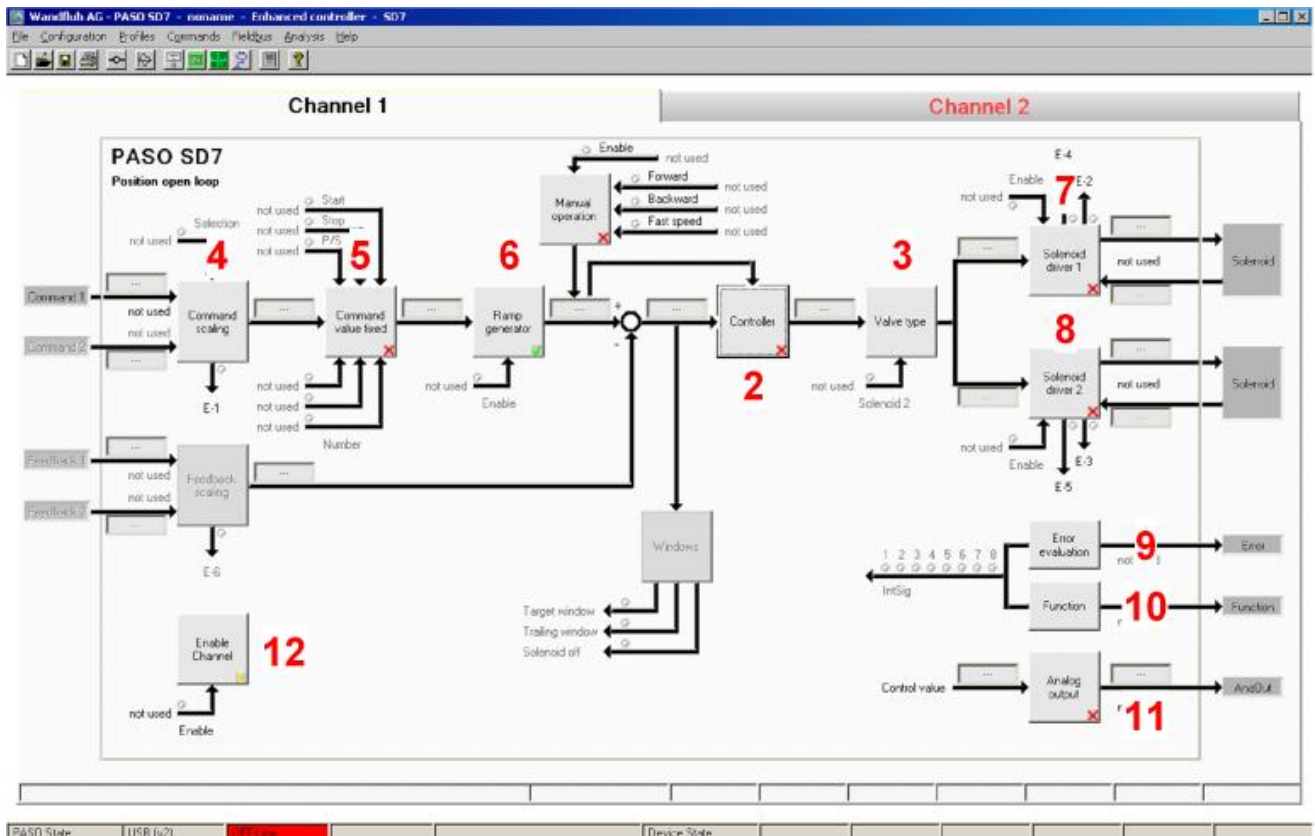

1. [Activate PASO Off Line mode](#) ^[14]
2. [Select controller mode](#) ^[14] (only with a SD7 controller)
3. [Select valve type](#) ^[14]
4. [Scale command signal](#) ^[15]
5. [Set command values fixed](#) ^[15] (optional)
6. [Set ramp generator](#) ^[16] (optional)
7. [Set solenoid driver 1](#) ^[16]
8. [Set solenoid driver 2](#) ^[16]
9. [Set error evaluation](#) ^[17] (optional)
10. [Set function](#) ^[17] (optional)
11. [Set analog output](#) ^[17] (optional, only possible with the Enhanced version)
12. [Set enable channel](#) ^[17]
13. [Save parameters in a file](#) ^[18] (optional)
14. [Activate PASO On Line mode](#) ^[19]
15. By activating the digital input 1, the channel 1 will be released in the controller mode "Position open loop"

3.2 Activate PASO Off Line mode

Select "File - Activate Off Line"



Select "OK"

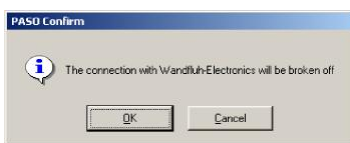

In the status line the message "Off-Line" appears

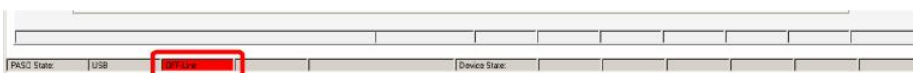

3.3 Select controller mode

Parameter	Description
Controller mode	Select controller mode "Position open loop"

All other parameters in this window will be set later.

3.4 Select valve type

Parameter	Description
Mode of operation	Select the corresponding mode of operation (in the example "Command unipolar (2-sol)")
Solenoid B	If the parameter "Mode of operation" is set to "Command unipolar (2-sol with DigInp)", the corresponding digital input can be selected here
Solenoid type	Select the solenoid type of the connected valve (in the example "Proportional solenoid with current measurement")

Valve type	Select the valve type of the connected valve (in the example "Standard 2-solenoid")
------------	---

3.5 Scale command signal

Command value 1

Parameter	Description
Signal type	Set the signal type from the command signal generator (in the example "Voltage")
Used analog input	If the parameter "Signal type" is set to "Voltage" or "Current", the input where the command signal generator is connect can be selected here (in the example "AnalInp1 [V]")
Used digital input	If the parameter "Signal type" is set to "Digital", "Frequency" or "PWM", the input where the command signal generator is connect can be selected here
Cablebreak detection	If the parameter "Signal type" is set to "Current", "Frequency" or "PWM", a cablebreak detection of the command signal generator can be activated
Lower cablebreak limit	If the parameter "Cablebreak detection" is set to "yes", the lower limit of this detection can be set here (command value < lower cablebreak limit = cablebreak)
Upper cablebreak limit	If the parameter "Cablebreak detection" is set to "yes", the upper limit of this detection can be set here (command value > upper cablebreak limit = cablebreak)
min interface	Set the minimum command signal level (in the example 0V)
max interface	Set the maximum command signal level (in the example 10V)
min Reference	Set the minimum desired scaled command value (correspond to the command value at "min interface", in the example 0%)
max Reference	Set the maximum desired scaled command value (correspond to the command value at "max interface", in the example 100%)
Function	Set the desired function for the second command signal input (in the example "not used")

General

Deadband function	Enable the deadband function
Deadband threshold	If the parameter "Deadband function" is set to "on", the threshold for the deadband can be set here (command value < deadband threshold => solenoid output = 0)

3.6 Set command values fixed

Parameter	Description
Enable	Enable the fixed command value function
Selection 1	Set the desired digital input for the fixed command value 1
Selection 2	Set the desired digital input for the fixed command value 2 and 3
Selection 4	Set the desired digital input for the fixed command value 4, 5, 6 and 7
Fixed command value 1	Set the desired command value for the fixed command value 1. This value becomes the active command value if the digital from "Selection 1" is activated
Fixed command value 2	Set the desired command value for the fixed command value 2. This value becomes the active command value if the digital from "Selection 2" is activated
Fixed command value 3	Set the desired command value for the fixed command value 3. This value becomes the active command value if the digital from "Selection 1" and "Selection 2" are activated together
Fixed command value 4	Set the desired command value for the fixed command value 4. This value becomes the active command value if the digital from "Selection 3" is activated
Fixed command value 5	Set the desired command value for the fixed command value 5. This value becomes the active command value if the digital from "Selection 1" and "Selection 4" are activated together

Fixed command value 6	Set the desired command value for the fixed command value 6. This value becomes the active command value if the digital from "Selection 2" and "Selection 4" are activated together
Fixed command value 7	Set the desired command value for the fixed command value 7. This value becomes the active command value if the digital from "Selection 1", "Selection 2" and "Selection 4" are activated together

3.7 Set ramp generator (optional)

Parameter	Description
Enable	Enable the ramp generator function
Ramp positive up	Ramptime for the current increase on solenoid driver 1
Ramp positive down	Ramptime for the current decrease on solenoid driver 1
Ramp negative up	Ramptime for the current increase on solenoid driver 2
Ramp negative down	Ramptime for the current decrease on solenoid driver 2

3.8 Set solenoid driver 1

Parameter	Description
Solenoid output	Select the output, where the solenoid for right turning is connected (in the example "SolOutA")
Enable	Selection, if the solenoid output is constantly enabled (selection "on"), constantly disabled (selection "off") or if it depends on a digital input (selection "external")
Dig. input	If the parameter "Enable" is set to "external", the corresponding digital input can be selected here
Inversion	If a solenoid with a inverse function is used, this selection should be "yes", otherwise "no"
Solenoid always active	In this control mode, this parameter must always be set to "no"
Cablebreak detection	If the cablebreak detection for the solenoid output is desired, this selection should be "yes", otherwise "no"
Characteristic optimisation	If the characteristic optimisation is desired, this selection should be "yes", otherwise "no". (the settings for the characteristic optimisation is made in the Tab-window "Characteristic optimisation")
Imin	Set the desired minimum current for solenoid A (correspond to the current at 0% command signal)
Imax	Set the desired maximum current for solenoid A (correspond to the current at 100% command signal)
Dither function	The dither function should be activated (Selection "on")
Dither frequency	Set the desired dither frequency value
Dither level	Set the desired dither level value

The remaining parameters have no function in this control mode

3.9 Set solenoid driver 2

Parameter	Description
Solenoid output	Select the output, where the solenoid for left turning is connected (in the example "SolOutB")
Enable	Selection, if the solenoid output is constantly enabled (selection "on"), constantly disabled (selection "off") or if it depends on a digital input (selection "external")
Dig. input	If the parameter "Enable" is set to "external", the corresponding digital input can be selected here

Inversion	If a solenoid with a inverse function is used, this selection should be "yes", otherwise "no"
Solenoid always active	In this control mode, this parameter must always be set to "no"
Cablebreak detection	If the cablebreak detection for the solenoid output is desired, this selection should be "yes", otherwise "no"
Characteristic optimisation	If the characteristic optimisation is desired, this selection should be "yes", otherwise "no". (the settings for the characteristic optimisation is made in the Tab-window "Characteristic optimisation")
Imin	Set the desired minimum current for solenoid B (correspond to the current at -0.1% command signal)
Imax	Set the desired maximum current for solenoid B (correspond to the current at -100% command signal)
Dither function	The dither function should be activated (Selection "on")
Dither frequency	Set the desired dither frequency value
Dither level	Set the desired dither level value

The remaining parameters have no function in this control mode

3.10 Set error evaluation (optional)

Parameter	Description
Selection	Here one can choose what error should activate the selected digital output
Dig. output	As soon as one of the selected error occurs, the selected digital output will be activated
Error action	With error "Cablebreak command signal", the desired error action can be set. The default setting is "Solenoid 1 + 2 off"

3.11 Set function (optional)

Parameter	Description
Selection	Here one can choose what function should activate the selected digital output

3.12 Set analog output (optional, only possible with the Enhanced version)

Parameter	Description
Signal	Select the desired signal which is to be performed on the analog output
Used output	Select the output, at which the desired signal is to be performed
min reference	Set the minimum signal level
max reference	Set the maximum signal level
min interface	Set the minimum desired output signal level (correspond to the output signal level at "min Interface")
max interface	Set the maximum desired output signal level (correspond to the output signal level at "max Interface")

3.13 Set enable channel

Parameter	Description
Enable	Selection, if the channel is constantly enabled (selection "on"), constantly disabled (selection "off") or if it depends on a digital input (selection "external")
Dig. input	If the parameter "Enable" is set to "external", the corresponding digital input can be selected here (in the example "DigInp1")

3.14 Save parameters in a file (optional)

Select "File - Save as ..."



Enter the directory and file name, afterwards select "OK"

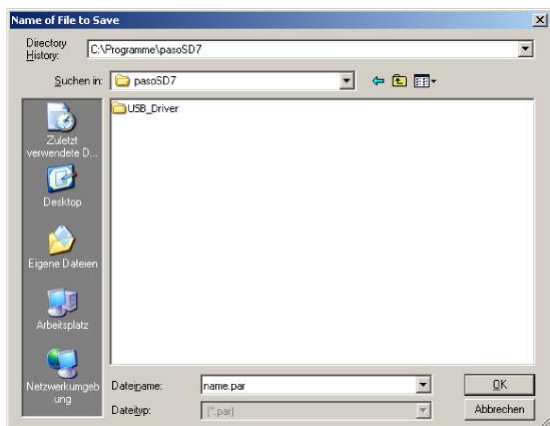

If required, enter the corresponding values to "Operator" and "Remarks", afterwards select "OK"

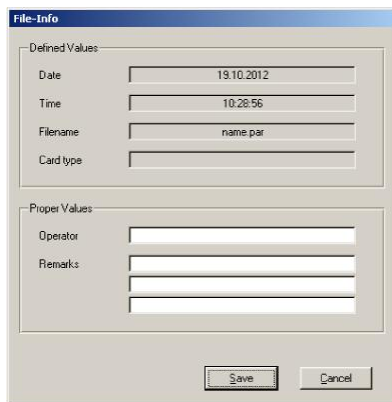

In the header line the corresponding file name appears

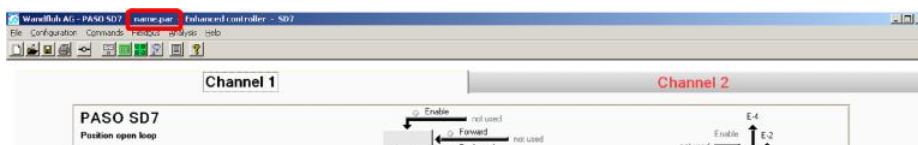

3.15 Activate PASO On Line mode

Select "File - Activate On Line"

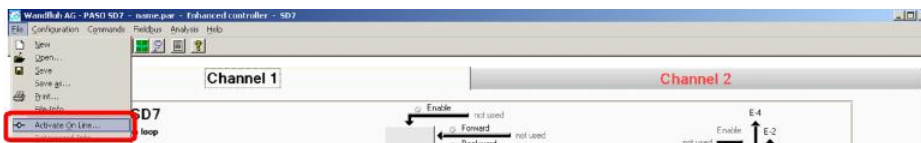

Select "Program the Wandfluh-Electronic with the new actual data?"

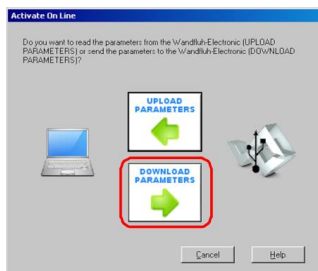

Select "OK"

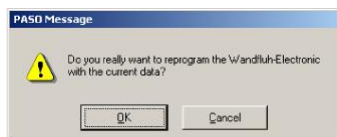

Select "OK"



Wait, until all parameters are sent to the MD2 Electronics

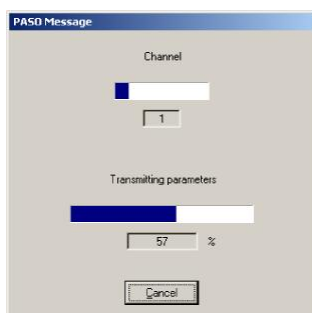

In the status line the message "On-Line" appears



4 Setup Instruction Pressure/flow valve closed loop (1-sol)

4.1 Introduction

This guide shows with an example how to set channel 1 of the SD7 Electronics as a pressure controller (1 solenoid)

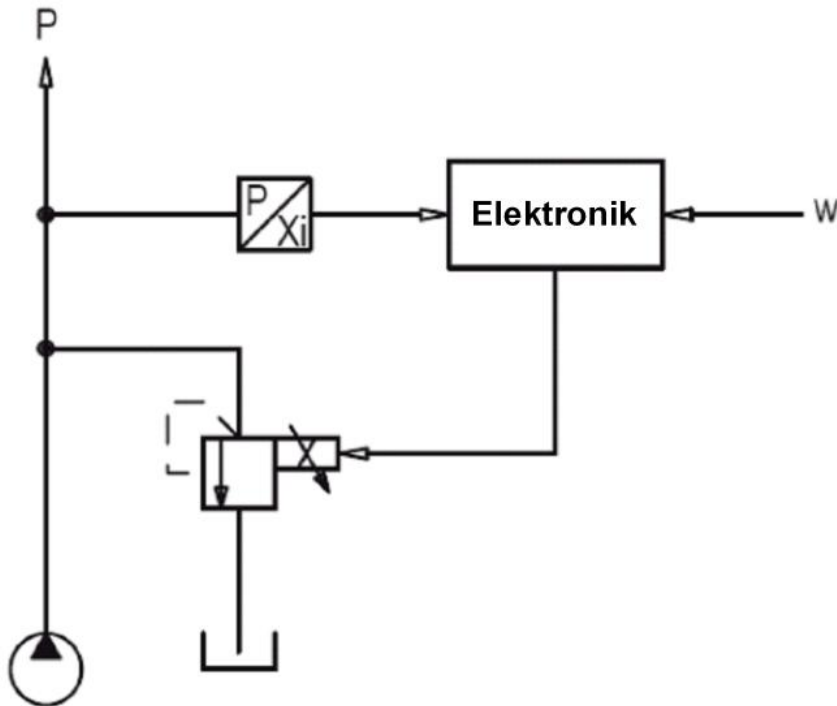

Pretended:

Controller mode: Pressure/flow valve closed loop (1-sol)

Command signal: 0 ... 20mA on analog input 1

Feedback signal: 0 ... 20mA on analog input 2

max. working 0 ... 200bar

pressure:

desired working 10 ... 190bar

pressure:

Valve connection: Proportional pressure relief valve on solenoid A

Enable channel: external via digital input 1

The following steps are necessary (steps with the remark "optional" are only necessary if needed):

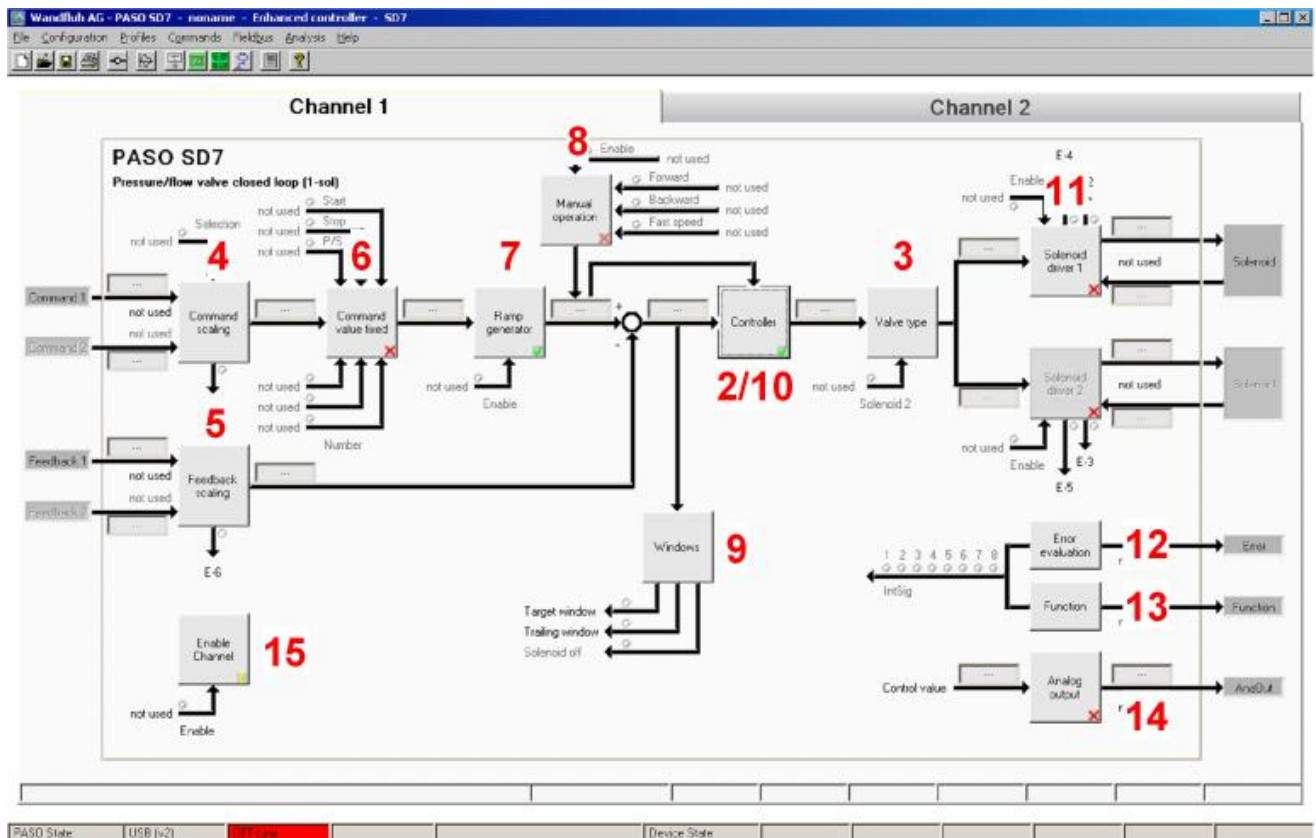

1. [Activate PASO Off Line mode](#) ^[22]
2. [Select controller mode](#) ^[22]
3. [Select valve type](#) ^[22]
4. [Scale command signal](#) ^[22]
5. [Scale feedback signal](#) ^[23]
6. [Set command values fixed](#) ^[23] (optional)
7. [Set speed](#) ^[24]
6. [Set manual operation](#) ^[24] (optional)
9. [Set windows](#) ^[24]
10. [Set controller](#) ^[25]
11. [Set solenoid driver 1](#) ^[25]
12. [Set error evaluation](#) ^[26] (optional)
13. [Set function](#) ^[26] (optional)
14. [Set analog output](#) ^[26] (optional, only possible with the Enhanced version)
15. [Set enable channel](#) ^[26]
16. [Save parameters in a file](#) ^[27] (optional)
17. [Activate PASO On Line mode](#) ^[28]
18. By activating the digital input 1, the channel 1 will be released in the controller mode "Pressure/flow valve closed loop (1-sol)"

4.2 Activate PASO Off Line mode

Select "File - Activate Off Line"

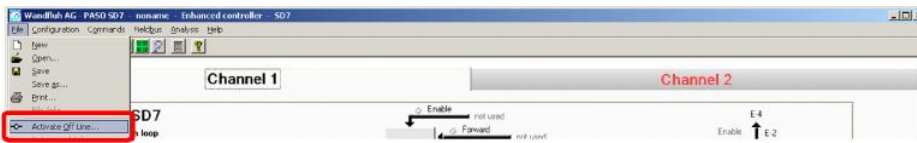

Select "OK"

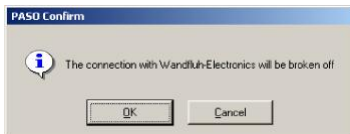

In the status line the message "Off-Line" appears



4.3 Select controller mode

Parameter	Description
Controller mode	Select controller mode "Pressure/flow valve closed loop (1-sol)"
Displayed unit	Select the desired unit (in the example "bar").

All other parameters in this window will be set later.

4.4 Select valve type

Parameter	Description
Solenoid type	Select the solenoid type of the connected valve (in the example "Proportional solenoid with current measurement")
Valve type	Select the valve type of the connected valve (in the example "Standard 2-solenoid")

The remaining parameters have no function in this control mode

4.5 Scale command signal

Parameter	Description
Signal type	Set the signal type from the command signal generator (in the example "Current")
Used analog input	If the parameter "Signal type" is set to "Voltage" or "Current", the input where the command signal generator is connect can be selected here (in the example "AnalInp1 [mA]")
Used digital input	If the parameter "Signal type" is set to "Digital", "Frequency" or "PWM", the input where the command signal generator is connect can be selected here
Cablebreak detection	If the parameter "Signal type" is set to "Current", "Frequency" or "PWM", a cablebreak detection of the command signal generator can be activated
Lower cablebreak limit	If the parameter "Cablebreak detection" is set to "yes", the lower limit of this detection can be set here (command value < lower cablebreak limit = cablebreak)

Upper cablebreak limit	If the parameter "Cablebreak detection" is set to "yes", the upper limit of this detection can be set here (command value > upper cablebreak limit = cablebreak)
min interface	Set the minimum command signal level (in the example 0mA)
max interface	Set the maximum command signal level (in the example 20mA)
min reference	Set the minimum desired pressure (correspond to the pressure at "min interface", in the example 10bar)
max reference	Set the maximum desired pressure (correspond to the pressure at "max interface", in the example 190bar)
Function	Set the desired function for the second command signal input (in the example "not used")

The remaining parameters have no function in this control mode

4.6 Scale feedback signal

Parameter	Description
Signal type	Set the signal type from the feedback signal generator (in the example "Current")
Used analog input	If the parameter "Signal type" is set to "Voltage" or "Current", the input where the feedback signal generator is connect can be selected here (in the example "AnalIn2 [mA]")
Used digital input	If the parameter "Signal type" is set to "Digital", "Frequency" or "PWM", the input where the feedback signal generator is connect can be selected here
Cablebreak detection	If the parameter "Signal type" is set to "Current", "Frequency" or "PWM", a cablebreak detection of the feedback signal generator can be activated
Lower cablebreak limit	If the parameter "Cablebreak detection" is set to "yes", the lower limit of this detection can be set here (feedback value < lower cablebreak limit = cablebreak)
Upper cablebreak limit	If the parameter "Cablebreak detection" is set to "yes", the upper limit of this detection can be set here (feedback value > upper cablebreak limit = cablebreak)
min interface	Set the minimum feedback signal level (correspond to the feedback signal level at "min reference", in the example 0mA)
max interface	Set the maximum feedback signal level (correspond to the feedback signal level at "max reference", in the example 20mA)
min reference	Set the minimum possible pressure (in the example 0bar)
max reference	Set the maximum possible pressure (in the example 200bar)
Function	Set the desired function for the second feedback signal input (in the example "not used")

4.7 Set command values fixed (optional)

Parameter	Description
Enable	Enable the fixed command value of the profile (only possible with the Enhanced function) function
Selection 1	Set the desired digital input for the fixed command value or profile 1
Selection 2	Set the desired digital input for the fixed command value or profile 2 and 3
Selection 4	Set the desired digital input for the fixed command value or profile 4, 5, 6 and 7
Fixed command value 1	Set the desired command value for the fixed command value 1. This value becomes the active command value if the digital from "Selection 1" is activated
Fixed command value 2	Set the desired command value for the fixed command value 2. This value becomes the active command value if the digital from "Selection 2" is activated
Fixed command value 3	Set the desired command value for the fixed command value 3. This value becomes the active command value if the digital from "Selection 1" and "Selection 2" are activated together
Fixed command value 4	Set the desired command value for the fixed command value 4. This value becomes the active command value if the digital from "Selection 3" is activated
Fixed command value 5	Set the desired command value for the fixed command value 5. This value becomes the active command value if the digital from "Selection 1" and "Selection 4" are activated together

Fixed command value 6	Set the desired command value for the fixed command value 6. This value becomes the active command value if the digital from "Selection 2" and "Selection 4" are activated together
Fixed command value 7	Set the desired command value for the fixed command value 7. This value becomes the active command value if the digital from "Selection 1", "Selection 2" and "Selection 4" are activated together
Selection 1	Set the desired profile number for the profile selection 1. This value becomes the active profile if the digital from "Selection 1" is activated
Selection 2	Set the desired profile number for the profile selection 2. This value becomes the active profile if the digital from "Selection 2" is activated
Selection 3	Set the desired profile number for the profile selection 3. This value becomes the active profile if the digital from "Selection 1" and "Selection 2" are activated together
Selection 4	Set the desired profile number for the profile selection 4. This value becomes the active profile if the digital from "Selection 3" is activated
Selection 5	Set the desired profile number for the profile selection 5. This value becomes the active profile if the digital from "Selection 1" and "Selection 4" are activated together
Selection 6	Set the desired profile number for the profile selection 6. This value becomes the active profile if the digital from "Selection 2" and "Selection 4" are activated together
Selection 7	Set the desired profile number for the profile selection 7. This value becomes the active profile if the digital from "Selection 1", "Selection 2" and "Selection 4" are activated together

4.8 Set speed

Parameter	Description
Speed +	This will set the pressure rise speed of the system (pressure rise = positive control deviation => command > feedback)
Speed -	This will set the pressure reducing speed of the system (pressure reducing = negative control deviation => command < feedback)
Acceleration +	This will set the pressure rise acceleration of the system (pressure rise = positive control deviation => command > feedback)
Acceleration -	This will set the pressure reducing acceleration of the system (pressure reducing = negative control deviation => command < feedback)
Deceleration +	This will set the pressure rise deceleration of the system (pressure rise = positive control deviation => command > feedback)
Deceleration -	This will set the pressure reducing deceleration of the system (pressure reducing = negative control deviation => command < feedback)

4.9 Set manual operation (optional)

Parameter	Description
Enable	Switch on / off the manual operation
Forward	Digital input for activating the forward function
Backward	Digital input for activating the backward function
Fast speed	Digital input for activating the fast speed
Slow speed	This will set the speed for the slow speed function (slow speed = digital input "Fast speed" not active)
Fast speed	This will set the speed for the fast speed function (fast speed = digital input "Fast speed" active)

4.10 Set windows

Parameter	Description
Target window type	Switch on/off the target window function
Target window threshold	Defines the target window range (control deviation < target window threshold = target window reached)
Target window delay time	Delay time when falling below and exceeding the target window threshold

Trailing window type	Switch on/off the trailing window function ATTENTION: With "on with error", the solenoid outputs will be disabled as soon as the trailing window is active!
Trailing window threshold	Defines the trailing window range (control deviation < trailing window threshold = trailing window reached)
Trailing window delay time	Delay time when falling below and exceeding the trailing window threshold
Solenoid-Off window type	Switch on/off the Solenoid-Off window function
Solenoid-Off window threshold	Defines the Solenoid-Off window range (control deviation < Solenoid-Off window threshold = solenoid are blocked)
Solenoid-Off window delay time	Delay time when falling below and exceeding the Solenoid-Off window threshold

In this control mode, the "Solenoid-Off" window must be set to "off".

4.11 Set controller

General

Parameter	Description
Command feed forward	The command value is multiplied with this factor and added to the correcting variable of the controller. If this factor is 0, no command value proportion is added to the correcting variable. Ideally, this value is set so that the deviation in the open loop is as small as possible. The deviation will not have the same size over the whole range. Thus, the smallest possible deviation can be set in the area where one will be mainly operate.
Velocity feed forward	In this control mode, this parameter must be set to 0

PID-controller

Using the parameters of the PID controller the control behavior can be set. The parameter "I window outside" should meet the highest deviation plus approx. about 10 bar

4.12 Set solenoid driver 1

Parameter	Description
Solenoid output	Select the output, where the solenoid for the loading valve is connected (in the example "SolOutA")
Enable	Selection, if the solenoid output is constantly enabled (selection "on"), constantly disabled (selection "off") or if it depends on a digital input (selection "external")
Dig. input	If the parameter "Enable" is set to "external", the corresponding digital input can be selected here
Inversion	If a solenoid with a inverse function is used, this selection should be "yes", otherwise "no"
Solenoid always active	In this control mode, this parameter must always be set to "no"
Cablebreak detection	If the cablebreak detection for the solenoid output is desired, this selection should be "yes", otherwise "no"
Characteristic optimisation	If the characteristic optimisation is desired, this selection should be "yes", otherwise "no". (the settings for the characteristic optimisation is made in the Tab-window "Characteristic optimisation")
Imin	Set the desired minimum current for solenoid A. The Imin should set in the way that with this value the desired minimum pressure will be reached
Imax	Set the desired maximum current for solenoid A. The Imax should be approx. the maximal desired pressure +5%
Dither function	The dither function should be activated (Selection "on")
Dither frequency	Set the desired dither frequency value
Dither level	Set the desired dither level value

The remaining parameters have no function in this control mode

4.13 Set error evaluation (optional)

Parameter	Description
Selection	Here one can choose what error should activate the selected digital output
Dig. output	As soon as one of the selected error occurs, the selected digital output will be activated
Error action	With error "Cablebreak command signal" and "Cablebreak feedback signal", the desired error action can be set. The default setting is "Solenoid 1 + 2 off"

4.14 Set function (optional)

Parameter	Description
Selection	Here one can choose what function should activate the selected digital output

4.15 Set analog output (optional, only possible with the Enhanced version)

Parameter	Description
Signal	Select the desired signal which is to be performed on the analog output
Used output	Select the output, at which the desired signal is to be performed
min reference	Set the minimum signal level
max reference	Set the maximum signal level
min interface	Set the minimum desired output signal level (correspond to the output signal level at "min Interface")
max interface	Set the maximum desired output signal level (correspond to the output signal level at "max Interface")

4.16 Set enable channel

Parameter	Description
Enable	Selection, if the channel is constantly enabled (selection "on"), constantly disabled (selection "off") or if it depends on a digital input (selection "external")
Dig. input	If the parameter "Enable" is set to "external", the corresponding digital input can be selected here (in the example "DigInp1")

4.17 Save parameters in a file

Select "File - Save as ..."



Enter the directory and file name, afterwards select "OK"

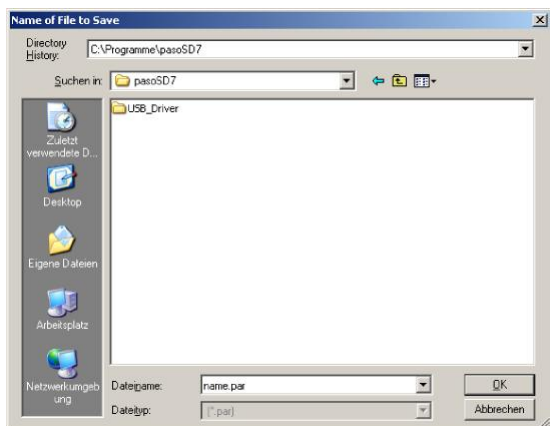

If required, enter the corresponding values to "Operator" and "Remarks", afterwards select "OK"

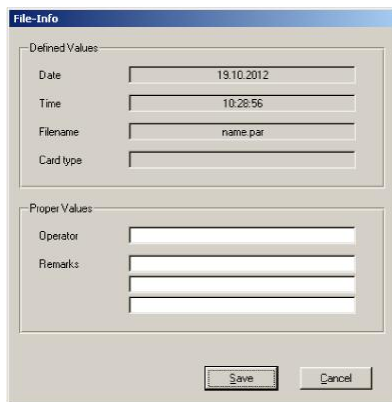

In the header line the corresponding file name appears

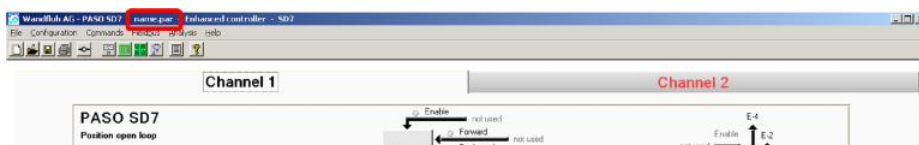

4.18 Activate PASO On Line mode

Select "File - Activate On Line"

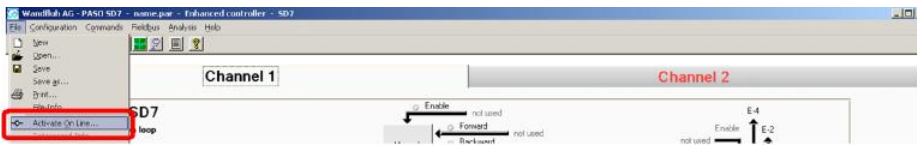

Select "Program the Wandfluh-Electronic with the new actual data?"

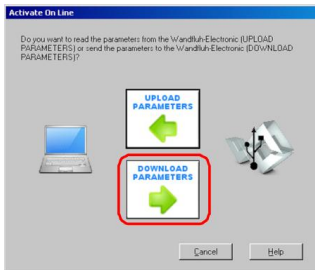

Select "OK"

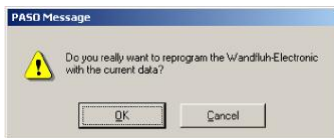

Select "OK"

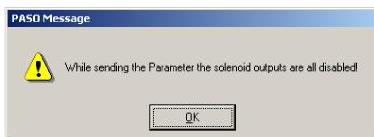

Wait, until all parameters are sent to the MD2 Electronics

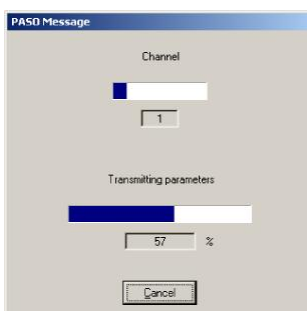

In the status line the message "On-Line" appears



5 Setup Instruction Pressure control closed loop (2-sol)

5.1 Introduction

This guide shows with an example how to set channel 1 of the SD7 Electronics as a pressure controller (2 solenoid)

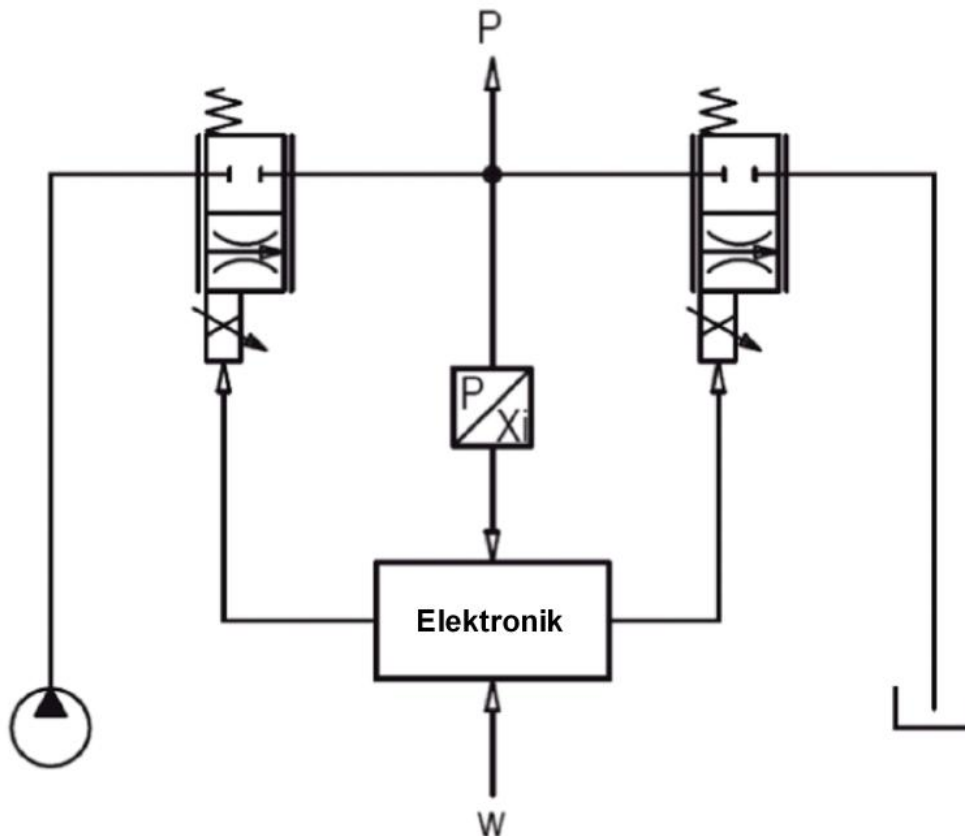

Pretended:

Controller mode: Pressure control closed loop (2-sol)

Command signal: 0 ... 20mA on analog input 1

Feedback signal: 0 ... 20mA on analog input 2

max. working 0 ... 300bar

pressure:

desired working 20 ... 250bar

pressure:

Valve connection: Proportional throttle valve on solenoid A (loading valve), proportional throttle valve on solenoid B (unloading valve)

Enable channel: external via digital input 1

The following steps are necessary (steps with the remark "optional" are only necessary if needed):

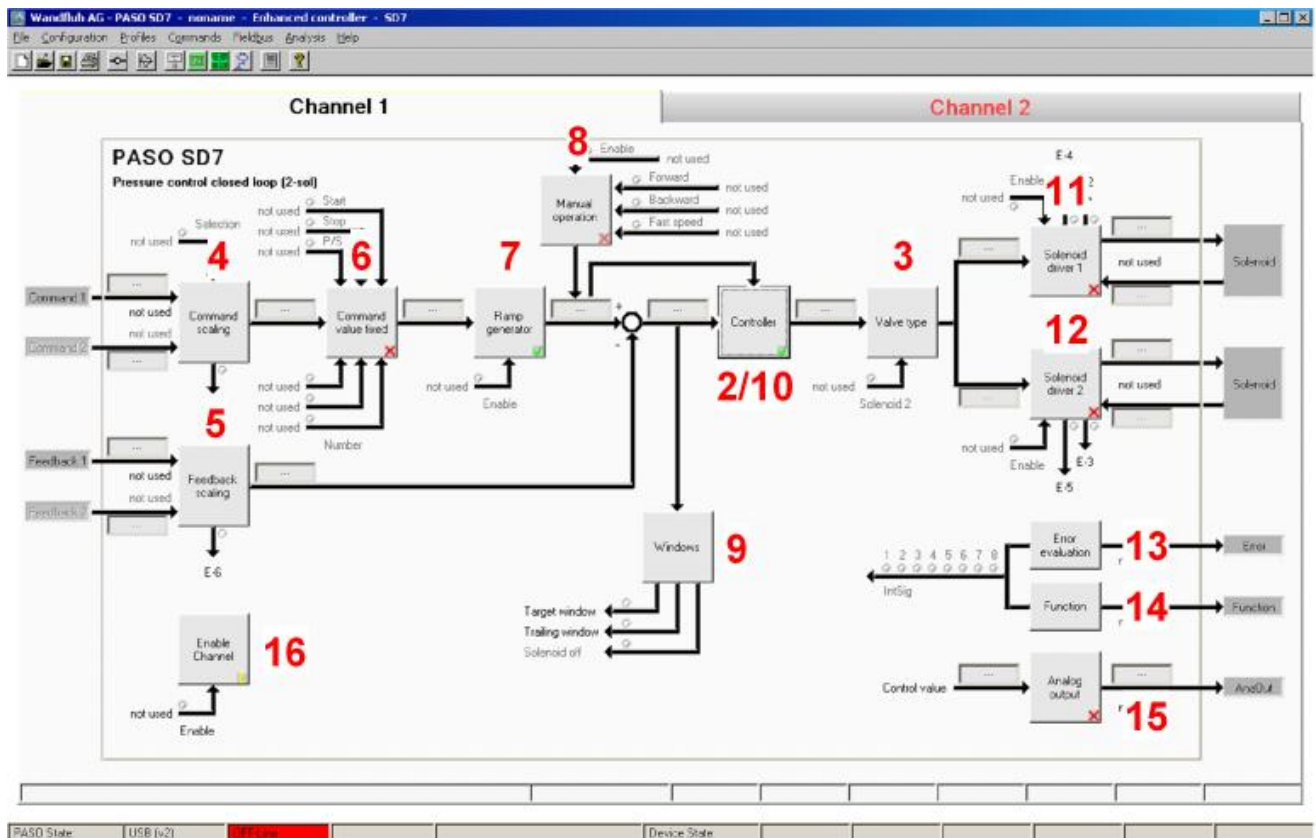

1. [Activate PASO Off Line mode](#) ³¹
2. [Select controller mode](#) ³¹
3. [Select valve type](#) ³¹
4. [Scale command signal](#) ³¹
5. [Scale feedback signal](#) ³²
6. [Set command values fixed](#) ³² (optional)
7. [Set speed](#) ³³
8. [Set manual operation](#) ³³ (optional)
9. [Set windows](#) ³³
10. [Set controller](#) ³⁴
11. [Set solenoid driver 1](#) ³⁴
12. [Set solenoid driver 2](#) ³⁵
13. [Set error evaluation](#) ³⁵ (optional)
14. [Set function](#) ³⁵ (optional)
15. [Set analog output](#) ³⁵ (optional, only possible with the Enhanced version)
16. [Set enable channel](#) ³⁶
17. [Save parameters in a file](#) ³⁷ (optional)
18. [Activate PASO On Line mode](#) ³⁸
19. By activating the digital input 1, the channel 1 will be released in the controller mode "Pressure control closed loop (2-sol)"

5.2 Activate PASO Off Line mode

Select "File - Activate Off Line"

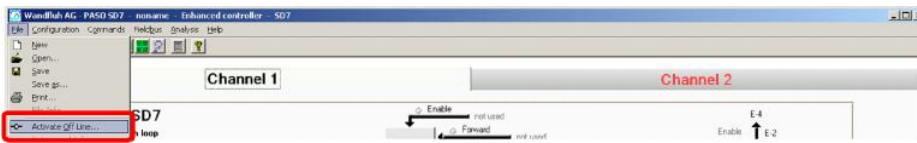

Select "OK"



In the status line the message "Off-Line" appears



5.3 Select controller mode

Parameter	Description
Controller mode	Select controller mode "Pressure control closed loop (2-sol)"
Displayed unit	Select the desired unit (in the example "bar").

All other parameters in this window will be set later.

5.4 Select valve type

Parameter	Description
Solenoid type	Select the solenoid type of the connected valve (in the example "Proportional solenoid with current measurement")
Valve type	Select the valve type of the connected valve (in the example "Standard 2-solenoid")

The remaining parameters have no function in this control mode

5.5 Scale command signal

Parameter	Description
Signal type	Set the signal type from the command signal generator (in the example "Current")
Used analog input	If the parameter "Signal type" is set to "Voltage" or "Current", the input where the command signal generator is connect can be selected here (in the example "AnalInp1 [mA]")
Used digital input	If the parameter "Signal type" is set to "Digital", "Frequency" or "PWM", the input where the command signal generator is connect can be selected here
Cablebreak detection	If the parameter "Signal type" is set to "Current", "Frequency" or "PWM", a cablebreak detection of the command signal generator can be activated
Lower cablebreak limit	If the parameter "Cablebreak detection" is set to "yes", the lower limit of this detection can be set here (command value < lower cablebreak limit = cablebreak)

Upper cablebreak limit	If the parameter "Cablebreak detection" is set to "yes", the upper limit of this detection can be set here (command value > upper cablebreak limit = cablebreak)
min interface	Set the minimum command signal level (in the example 0mA)
max interface	Set the maximum command signal level (in the example 20mA)
min reference	Set the minimum desired pressure (correspond to the pressure at "min interface", in the example 20bar)
max reference	Set the maximum desired pressure (correspond to the pressure at "max interface", in the example 250bar)
Function	Set the desired function for the second command signal input (in the example "not used")

The remaining parameters have no function in this control mode

5.6 Scale feedback signal

Parameter	Description
Signal type	Set the signal type from the feedback signal generator (in the example "Current")
Used analog input	If the parameter "Signal type" is set to "Voltage" or "Current", the input where the feedback signal generator is connect can be selected here (in the example "AnalIn2 [mA]")
Used digital input	If the parameter "Signal type" is set to "Digital", "Frequency" or "PWM", the input where the feedback signal generator is connect can be selected here
Cablebreak detection	If the parameter "Signal type" is set to "Current", "Frequency" or "PWM", a cablebreak detection of the feedback signal generator can be activated
Lower cablebreak limit	If the parameter "Cablebreak detection" is set to "yes", the lower limit of this detection can be set here (feedback value < lower cablebreak limit = cablebreak)
Upper cablebreak limit	If the parameter "Cablebreak detection" is set to "yes", the upper limit of this detection can be set here (feedback value > upper cablebreak limit = cablebreak)
min interface	Set the minimum feedback signal level (correspond to the feedback signal level at "min reference", in the example 0mA)
max interface	Set the maximum feedback signal level (correspond to the feedback signal level at "max reference", in the example 20mA)
min reference	Set the minimum possible pressure (in the example 0bar)
max reference	Set the maximum possible pressure (in the example 300bar)
Function	Set the desired function for the second feedback signal input (in the example "not used")

5.7 Set command values fixed (optional)

Parameter	Description
Enable	Enable the fixed command value of the profile (only possible with the Enhanced function) function
Selection 1	Set the desired digital input for the fixed command value or profile 1
Selection 2	Set the desired digital input for the fixed command value or profile 2 and 3
Selection 4	Set the desired digital input for the fixed command value or profile 4, 5, 6 and 7
Fixed command value 1	Set the desired command value for the fixed command value 1. This value becomes the active command value if the digital from "Selection 1" is activated
Fixed command value 2	Set the desired command value for the fixed command value 2. This value becomes the active command value if the digital from "Selection 2" is activated
Fixed command value 3	Set the desired command value for the fixed command value 3. This value becomes the active command value if the digital from "Selection 1" and "Selection 2" are activated together
Fixed command value 4	Set the desired command value for the fixed command value 4. This value becomes the active command value if the digital from "Selection 3" is activated
Fixed command value 5	Set the desired command value for the fixed command value 5. This value becomes the active command value if the digital from "Selection 1" and "Selection 4" are activated together

Fixed command value 6	Set the desired command value for the fixed command value 6. This value becomes the active command value if the digital from "Selection 2" and "Selection 4" are activated together
Fixed command value 7	Set the desired command value for the fixed command value 7. This value becomes the active command value if the digital from "Selection 1", "Selection 2" and "Selection 4" are activated together
Selection 1	Set the desired profile number for the profile selection 1. This value becomes the active profile if the digital from "Selection 1" is activated
Selection 2	Set the desired profile number for the profile selection 2. This value becomes the active profile if the digital from "Selection 2" is activated
Selection 3	Set the desired profile number for the profile selection 3. This value becomes the active profile if the digital from "Selection 1" and "Selection 2" are activated together
Selection 4	Set the desired profile number for the profile selection 4. This value becomes the active profile if the digital from "Selection 3" is activated
Selection 5	Set the desired profile number for the profile selection 5. This value becomes the active profile if the digital from "Selection 1" and "Selection 4" are activated together
Selection 6	Set the desired profile number for the profile selection 6. This value becomes the active profile if the digital from "Selection 2" and "Selection 4" are activated together
Selection 7	Set the desired profile number for the profile selection 7. This value becomes the active profile if the digital from "Selection 1", "Selection 2" and "Selection 4" are activated together

5.8 Set speed

Parameter	Description
Speed +	This will set the pressure rise speed of the system (pressure rise = positive control deviation => command > feedback)
Speed -	This will set the pressure reducing speed of the system (pressure reducing = negative control deviation => command < feedback)
Acceleration +	This will set the pressure rise acceleration of the system (pressure rise = positive control deviation => command > feedback)
Acceleration -	This will set the pressure reducing acceleration of the system (pressure reducing = negative control deviation => command < feedback)
Deceleration +	This will set the pressure rise deceleration of the system (pressure rise = positive control deviation => command > feedback)
Deceleration -	This will set the pressure reducing deceleration of the system (pressure reducing = negative control deviation => command < feedback)

5.9 Set manual operation (optional)

Parameter	Description
Enable	Switch on / off the manual operation
Forward	Digital input for activating the forward function
Backward	Digital input for activating the backward function
Fast speed	Digital input for activating the fast speed
Slow speed	This will set the speed for the slow speed function (slow speed = digital input "Fast speed" not active)
Fast speed	This will set the speed for the fast speed function (fast speed = digital input "Fast speed" active)

5.10 Set windows

Parameter	Description
Target window type	Switch on/off the target window function
Target window threshold	Defines the target window range (control deviation < target window threshold = target window reached)
Target window delay time	Delay time when falling below and exceeding the target window threshold

Trailing window type	Switch on/off the trailing window function ATTENTION: With "on with error", the solenoid outputs will be disabled as soon as the trailing window is active!
Trailing window threshold	Defines the trailing window range (control deviation < trailing window threshold = trailing window reached)
Trailing window delay time	Delay time when falling below and exceeding the trailing window threshold
Solenoid-Off window type	Switch on/off the Solenoid-Off window function
Solenoid-Off window threshold	Defines the Solenoid-Off window range (control deviation < Solenoid-Off window threshold = solenoid are blocked)
Solenoid-Off window delay time	Delay time when falling below and exceeding the Solenoid-Off window threshold

In this control mode, the "Solenoid-Off" window must be set to "off".

5.11 Set controller

General

Parameter	Description
Command feed forward	The command value is multiplied with this factor and added to the correcting variable of the controller. If this factor is 0, no command value proportion is added to the correcting variable. Ideally, this value is set so that the deviation in the open loop is as small as possible. The deviation will not have the same size over the whole range. Thus, the smallest possible deviation can be set in the area where one will be mainly operate.
Velocity feed forward	In this control mode, this parameter must be set to 0

PID-controller

Using the parameters of the PID controller the control behavior can be set. The parameter "I window outside" should meet the highest deviation plus approx. about 10 bar

5.12 Set solenoid driver 1

Parameter	Description
Solenoid output	Select the output, where the solenoid for the loading valve is connected (in the example "SolOutA")
Enable	Selection, if the solenoid output is constantly enabled (selection "on"), constantly disabled (selection "off") or if it depends on a digital input (selection "external")
Dig. input	If the parameter "Enable" is set to "external", the corresponding digital input can be selected here
Inversion	If a solenoid with a inverse function is used, this selection should be "yes", otherwise "no"
Solenoid always active	In this control mode, this parameter must always be set to "no"
Cablebreak detection	If the cablebreak detection for the solenoid output is desired, this selection should be "yes", otherwise "no"
Characteristic optimisation	If the characteristic optimisation is desired, this selection should be "yes", otherwise "no". (the settings for the characteristic optimisation is made in the Tab-window "Characteristic optimisation")
Imin	Set the desired minimum current for solenoid A. The Imin should set in the way that with this value the desired minimum pressure will be reached
Imax	Set the desired maximum current for solenoid A. The Imax should be approx. the maximal desired pressure +5%
Dither function	The dither function should be activated (Selection "on")
Dither frequency	Set the desired dither frequency value
Dither level	Set the desired dither level value

The remaining parameters have no function in this control mode

5.13 Set solenoid driver 2

Parameter	Description
Solenoid output	Select the output, where the solenoid for the unloading is connected (in the example "SolOutA")
Enable	Selection, if the solenoid output is constantly enabled (selection "on"), constantly disabled (selection "off") or if it depends on a digital input (selection "external")
Dig. input	If the parameter "Enable" is set to "external", the corresponding digital input can be selected here
Inversion	If a solenoid with a inverse function is used, this selection should be "yes", otherwise "no"
Solenoid always active	In this control mode, this parameter must always be set to "no"
Cablebreak detection	If the cablebreak detection for the solenoid output is desired, this selection should be "yes", otherwise "no"
Characteristic optimisation	If the characteristic optimisation is desired, this selection should be "yes", otherwise "no". (the settings for the characteristic optimisation is made in the Tab-window "Characteristic optimisation")
Imin	Set the desired minimum current for solenoid A. The Imin should set in the way that with this value the desired minimum pressure will be reached
Imax	Set the desired maximum current for solenoid A. The Imax should be approx. the maximal desired pressure +5%
Dither function	The dither function should be activated (Selection "on")
Dither frequency	Set the desired dither frequency value
Dither level	Set the desired dither level value

The remaining parameters have no function in this control mode

5.14 Set error evaluation (optional)

Parameter	Description
Selection	Here one can choose what error should activate the selected digital output
Dig. output	As soon as one of the selected error occurs, the selected digital output will be activated
Error action	With error "Cablebreak command signal" and "Cablebreak feedback signal", the desired error action can be set. The default setting is "Solenoid 1 + 2 off"

5.15 Set function (optional)

Parameter	Description
Selection	Here one can choose what function should activate the selected digital output

5.16 Set analog output (optional, only possible with the Enhanced version)

Parameter	Description
Signal	Select the desired signal which is to be performed on the analog output
Used output	Select the output, at which the desired signal is to be performed
min reference	Set the minimum signal level
max reference	Set the maximum signal level
min interface	Set the minimum desired output signal level (correspond to the output signal level at "min Interface")
max interface	Set the maximum desired output signal level (correspond to the output signal level at

"max Interface")

5.17 Set enable channel

Parameter	Description
Enable	Selection, if the channel is constantly enabled (selection "on"), constantly disabled (selection "off") or if it depends on a digital input (selection "external")
Dig. input	If the parameter "Enable" is set to *external", the corresponding digital input can be selected here (in the example "DigInp1")

5.18 Save parameters in a file (optional)

Select "File - Save as ..."



Enter the directory and file name, afterwards select "OK"

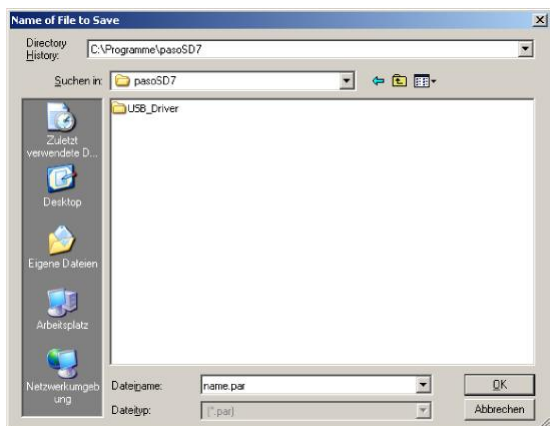

If required, enter the corresponding values to "Operator" and "Remarks", afterwards select "OK"

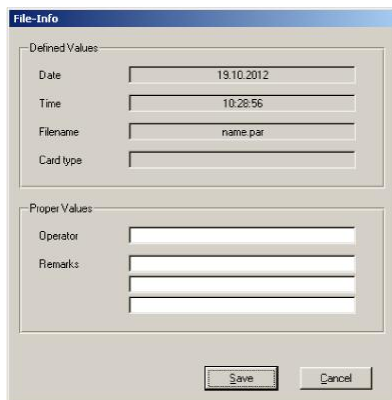

In the header line the corresponding file name appears

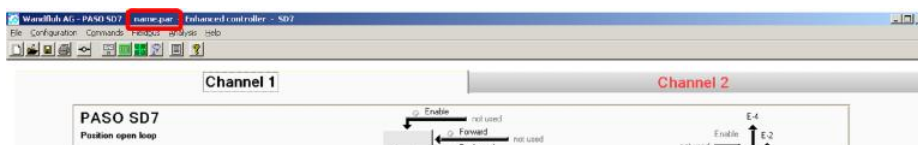

5.19 Activate PASO On Line mode

Select "File - Activate On Line"

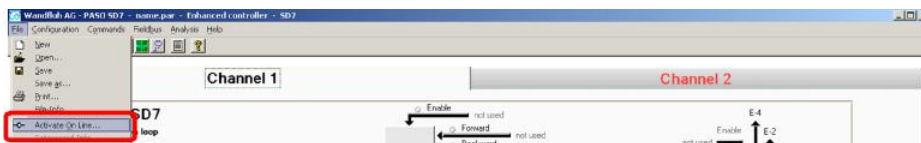

Select "Program the Wandfluh-Electronic with the new actual data?"

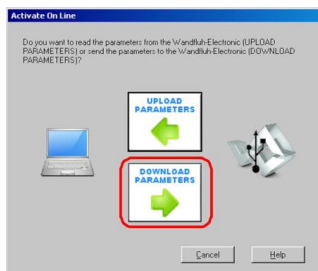

Select "OK"

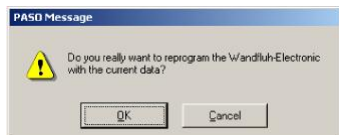

Select "OK"



Wait, until all parameters are sent to the MD2 Electronics

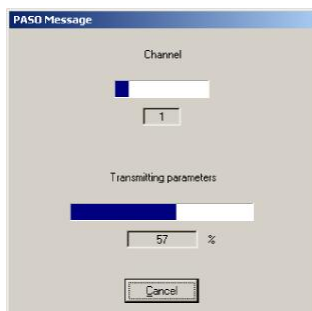

In the status line the message "On-Line" appears



6 Setup Instruction Position closed loop (2-sol)

6.1 Introduction

This guide shows with an example how to set channel 1 of the SD7 Electronics as a position controller.

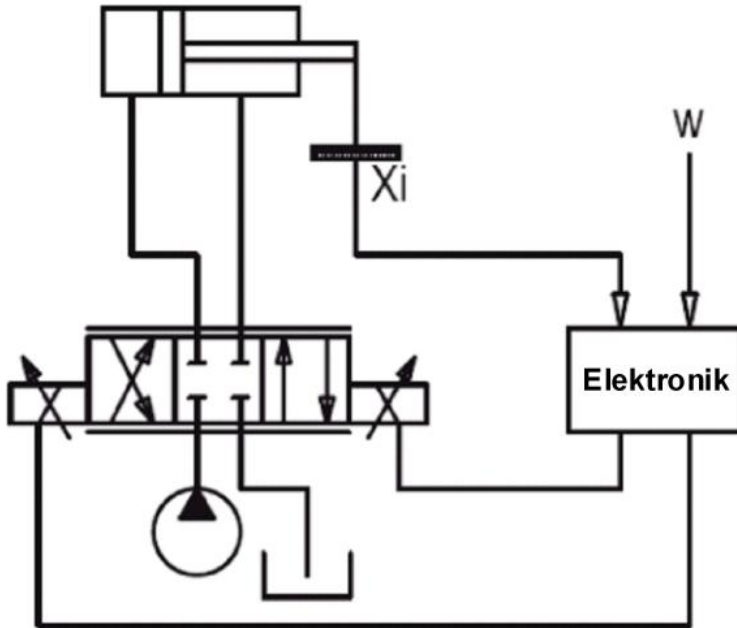

Pretended:

Controller mode: Position closed loop (2-sol)

Command signal: 0 ... 10V on analog input 1

Feedback signal: 0 ... 10V on analog input 2

max. working stroke: 0 ... 500mm

desired working stroke: 20 ... 480mm

stroke:

Valve connection: 4/3-way proportional valve, extend = solenoid A, retract = solenoid B

Enable channel: external via digital input 1

The following steps are necessary (steps with the remark "optional" are only necessary if needed):

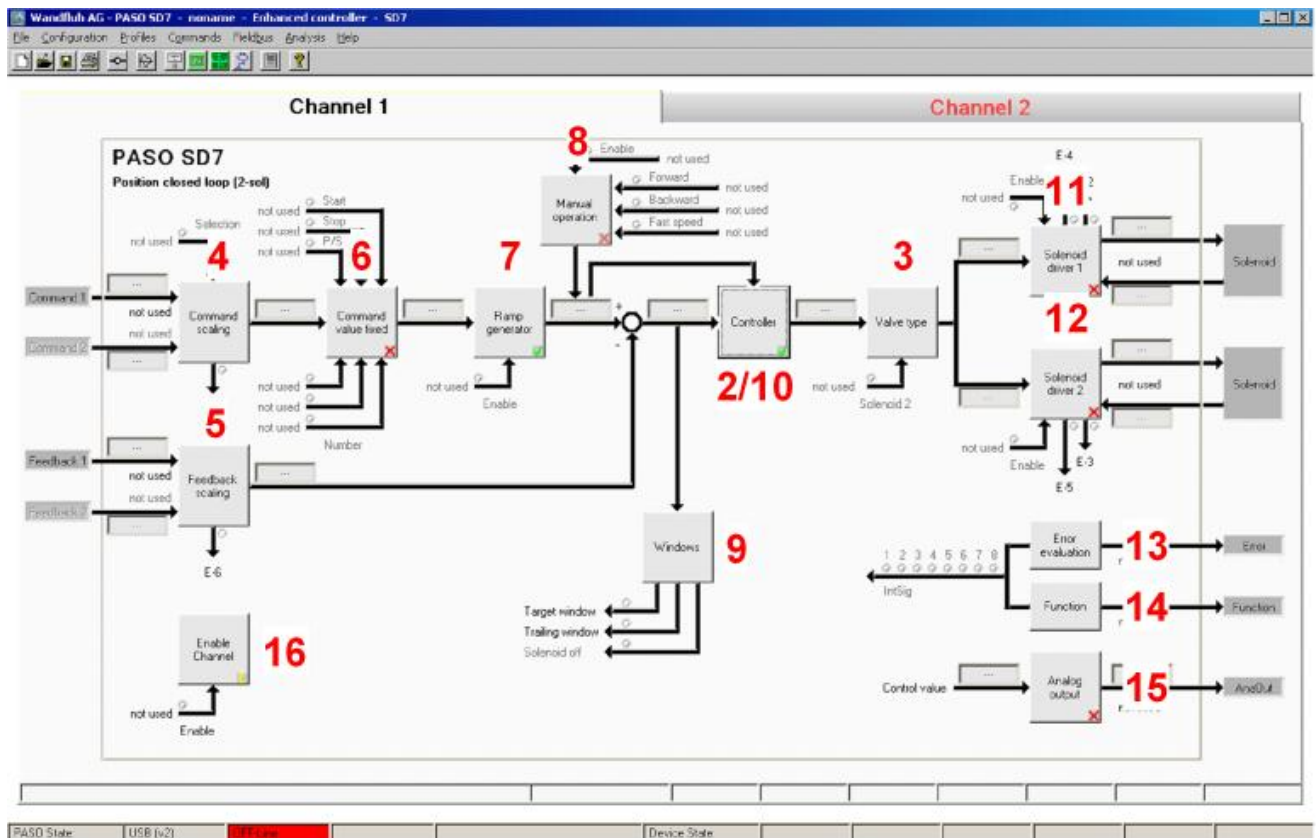

1. [Activate PASO Off Line mode](#) ^[41]
2. [Select controller mode](#) ^[41]
3. [Select valve type](#) ^[41]
4. [Scale command signal](#) ^[41]
5. [Scale feedback signal](#) ^[42]
6. [Set command values fixed](#) ^[42] (optional)
7. [Set speed](#) ^[43]
8. [Set manual operation](#) ^[43] (optional)
9. [Set windows](#) ^[43]
10. [Set controller](#) ^[44]
11. [Set solenoid driver 1](#) ^[44]
12. [Set solenoid driver 2](#) ^[45]
13. [Set error evaluation](#) ^[45] (optional)
14. [Set function](#) ^[45] (optional)
15. [Set analog output](#) ^[45] (optional, only possible with the Enhanced version)
16. [Set enable channel](#) ^[46]
17. [Save parameters in a file](#) ^[47] (optional)
18. [Activate PASO On Line mode](#) ^[48]
19. By activating the digital input 1, the channel 1 will be released in the controller mode "Position open loop"

6.2 Activate PASO Off Line mode

Select "File - Activate Off Line"

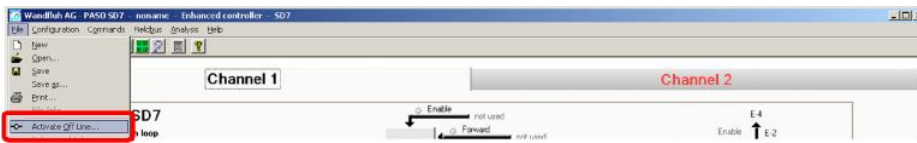

Select "OK"

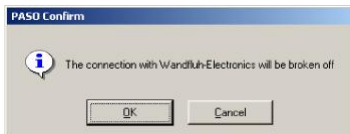

In the status line the message "Off-Line" appears



6.3 Select controller mode

Parameter	Description
Controller mode	Select controller mode "Position closed loop (2-sol)"
Displayed unit	Select the desired unit (in the example "mm")

All other parameters in this window will be set later.

6.4 Select valve type

Parameter	Description
Solenoid type	Select the solenoid type of the connected valve (in the example "Proportional solenoid with current measurement")
Valve type	Select the valve type of the connected valve (in the example "Standard 2-solenoid")

The remaining parameters have no function in this control mode

6.5 Scale command signal

Parameter	Description
Signal type	Set the signal type from the command signal generator (in the example "Voltage")
Used analog input	If the parameter "Signal type" is set to "Voltage" or "Current", the input where the command signal generator is connect can be selected here (in the example "AnalInp1 [V]")
Used digital input	If the parameter "Signal type" is set to "Digital", "Frequency" or "PWM", the input where the command signal generator is connect can be selected here
Cablebreak detection	If the parameter "Signal type" is set to "Current", "Frequency" or "PWM", a cablebreak detection of the command signal generator can be activated
Lower cablebreak limit	If the parameter "Cablebreak detection" is set to "yes", the lower limit of this detection can be set here (command value < lower cablebreak limit = cablebreak)

Upper cablebreak limit	If the parameter "Cablebreak detection" is set to "yes", the upper limit of this detection can be set here (command value > upper cablebreak limit = cablebreak)
min interface	Set the minimum command signal level (in the example 0V)
max interface	Set the maximum command signal level (in the example 10V)
min reference	Set the minimum desired stroke (correspond to the stroke at "min interface", in the example 20mm)
max reference	Set the maximum desired stroke (correspond to the stroke at "max interface", in the example 480mm)
Function	Set the desired function for the second command signal input (in the example "not used")

The remaining parameters have no function in this control mode

6.6 Scale feedback signal

Parameter	Description
Signal type	Set the signal type from the feedback signal generator (in the example "Voltage")
Used analog input	If the parameter "Signal type" is set to "Voltage" or "Current", the input where the feedback signal generator is connect can be selected here (in the example "AnalInp2 [V]")
Used digital input	If the parameter "Signal type" is set to "Digital", "Frequency" or "PWM", the input where the feedback signal generator is connect can be selected here
Cablebreak detection	If the parameter "Signal type" is set to "Current", "Frequency" or "PWM", a cablebreak detection of the feedback signal generator can be activated
Lower cablebreak limit	If the parameter "Cablebreak detection" is set to "yes", the lower limit of this detection can be set here (feedback value < lower cablebreak limit = cablebreak)
Upper cablebreak limit	If the parameter "Cablebreak detection" is set to "yes", the upper limit of this detection can be set here (feedback value > upper cablebreak limit = cablebreak)
min interface	Set the minimum feedback signal level (correspond to the feedback signal level at "min reference", in the example 0V)
max interface	Set the maximum feedback signal level (correspond to the feedback signal level at "max reference", in the example 10V)
min reference	Set the minimum possible stroke (in the example 0mm)
max reference	Set the maximum possible stroke (in the example 500mm)
Function	Set the desired function for the second feedback signal input (in the example "not used")

6.7 Set command values fixed (optional)

Parameter	Description
Enable	Enable the fixed command value of the profile (only possible with the Enhanced function) function
Selection 1	Set the desired digital input for the fixed command value or profile 1
Selection 2	Set the desired digital input for the fixed command value or profile 2 and 3
Selection 4	Set the desired digital input for the fixed command value or profile 4, 5, 6 and 7
Fixed command value 1	Set the desired command value for the fixed command value 1. This value becomes the active command value if the digital from "Selection 1" is activated
Fixed command value 2	Set the desired command value for the fixed command value 2. This value becomes the active command value if the digital from "Selection 2" is activated
Fixed command value 3	Set the desired command value for the fixed command value 3. This value becomes the active command value if the digital from "Selection 1" and "Selection 2" are activated together
Fixed command value 4	Set the desired command value for the fixed command value 4. This value becomes the active command value if the digital from "Selection 3" is activated
Fixed command value 5	Set the desired command value for the fixed command value 5. This value becomes the active command value if the digital from "Selection 1" and "Selection 4" are activated together

Fixed command value 6	Set the desired command value for the fixed command value 6. This value becomes the active command value if the digital from "Selection 2" and "Selection 4" are activated together
Fixed command value 7	Set the desired command value for the fixed command value 7. This value becomes the active command value if the digital from "Selection 1", "Selection 2" and "Selection 4" are activated together
Selection 1	Set the desired profile number for the profile selection 1. This value becomes the active profile if the digital from "Selection 1" is activated
Selection 2	Set the desired profile number for the profile selection 2. This value becomes the active profile if the digital from "Selection 2" is activated
Selection 3	Set the desired profile number for the profile selection 3. This value becomes the active profile if the digital from "Selection 1" and "Selection 2" are activated together
Selection 4	Set the desired profile number for the profile selection 4. This value becomes the active profile if the digital from "Selection 3" is activated
Selection 5	Set the desired profile number for the profile selection 5. This value becomes the active profile if the digital from "Selection 1" and "Selection 4" are activated together
Selection 6	Set the desired profile number for the profile selection 6. This value becomes the active profile if the digital from "Selection 2" and "Selection 4" are activated together
Selection 7	Set the desired profile number for the profile selection 7. This value becomes the active profile if the digital from "Selection 1", "Selection 2" and "Selection 4" are activated together

6.8 Set speed

Parameter	Description
Speed +	This will set the extend speed of the system (extend = positive control deviation => command > feedback)
Speed -	This will set the retract speed of the system (retract = negative control deviation => command < feedback)
Acceleration +	This will set the extend acceleration of the system (extend = positive control deviation => command > feedback)
Acceleration -	This will set the retract acceleration of the system (retract = negative control deviation => command < feedback)
Deceleration +	This will set the extend deceleration of the system (extend = positive control deviation => command > feedback)
Deceleration -	This will set the retract deceleration of the system (retract = negative control deviation => command < feedback)

6.9 Set manual operation (optional)

Parameter	Description
Enable	Switch on / off the manual operation
Forward	Digital input for activating the forward function
Backward	Digital input for activating the backward function
Fast speed	Digital input for activating the fast speed
Slow speed	This will set the speed for the slow speed function (slow speed = digital input "Fast speed" not active)
Fast speed	This will set the speed for the fast speed function (fast speed = digital input "Fast speed" active)

6.10 Set windows

Parameter	Description
Target window type	Switch on/off the target window function
Target window threshold	Defines the target window range (control deviation < target window threshold = target window reached)
Target window delay time	Delay time when falling below and exceeding the target window threshold

Trailing window type	Switch on/off the trailing window function ATTENTION: With "on with error", the solenoid outputs will be disabled as soon as the trailing window is active!
Trailing window threshold	Defines the trailing window range (control deviation < trailing window threshold = trailing window reached)
Trailing window delay time	Delay time when falling below and exceeding the trailing window threshold
Solenoid-Off window type	Switch on/off the Solenoid-Off window function
Solenoid-Off window threshold	Defines the Solenoid-Off window range (control deviation < Solenoid-Off window threshold = solenoid are blocked)
Solenoid-Off window delay time	Delay time when falling below and exceeding the Solenoid-Off window threshold

6.11 Set controller

General

Parameter	Description
Command feed forward	In this control mode, this parameter must be set to 0
Velocity feed forward	This will accelerate the driving off of the cylinder. The change of the command value (the increase speed of the command value) is multiplied with this factor and added to the correcting variable of the controller. If this factor is 0, no command value addition is added to the correcting variable.

PID controller

Using the parameters of the PID controller the control behavior can be set. Because the position control is a dynamic control, the I-part can be omitted in many cases.

6.12 Set solenoid driver 1

Parameter	Description
Solenoid output	Select the output, where the solenoid for the extension is connected (in the example "SolOutA")
Enable	Selection, if the solenoid output is constantly enabled (selection "on"), constantly disabled (selection "off") or if it depends on a digital input (selection "external")
Dig. input	If the parameter "Enable" is set to "external", the corresponding digital input can be selected here
Inversion	If a solenoid with a inverse function is used, this selection should be "yes", otherwise "no"
Solenoid always active	In this control mode, this parameter must always be set to "no"
Cablebreak detection	If the cablebreak detection for the solenoid output is desired, this selection should be "yes", otherwise "no"
Characteristic optimisation	If the characteristic optimisation is desired, this selection should be "yes", otherwise "no". (the settings for the characteristic optimisation is made in the Tab-window "Characteristic optimisation")
Imin	Set the desired minimum current for solenoid A. The Imin should be set in a way that the axis just moved slightly at this value.
Imax	Set the desired maximum current for solenoid A. The Imax should be approx. the nominal current from the solenoid +5%
Dither function	The dither function should be activated (Selection "on")
Dither frequency	Set the desired dither frequency value
Dither level	Set the desired dither level value

The remaining parameters have no function in this control mode

6.13 Set solenoid driver 2

Parameter	Description
Solenoid output	Select the output, where the solenoid for the retracting is connected (in the example "SolOutB")
Enable	Selection, if the solenoid output is constantly enabled (selection "on"), constantly disabled (selection "off") or if it depends on a digital input (selection "external")
Dig. input	If the parameter "Enable" is set to "external", the corresponding digital input can be selected here
Inversion	If a solenoid with a inverse function is used, this selection should be "yes", otherwise "no"
Solenoid always active	In this control mode, this parameter must always be set to "no"
Cablebreak detection	If the cablebreak detection for the solenoid output is desired, this selection should be "yes", otherwise "no"
Characteristic optimisation	If the characteristic optimisation is desired, this selection should be "yes", otherwise "no". (the settings for the characteristic optimisation is made in the Tab-window "Characteristic optimisation")
min	Set the desired minimum current for solenoid B. The Imin should be set in a way that the axis just moved slightly at this value.
Imax	Set the desired maximum current for solenoid B. The Imax should be approx. the nominal current from the solenoid +5%
Dither function	The dither function should be activated (Selection "on")
Dither frequency	Set the desired dither frequency value
Dither level	Set the desired dither level value

The remaining parameters have no function in this control mode

6.14 Set error evaluation (optional)

Parameter	Description
Selection	Here one can choose what error should activate the selected digital output
Dig. output	As soon as one of the selected error occurs, the selected digital output will be activated
Error action	With error "Cablebreak command signal" and "Cablebreak feedback signal", the desired error action can be set. The default setting is "Solenoid 1 + 2 off"

6.15 Set function (optional)

Parameter	Description
Selection	Here one can choose what function should activate the selected digital output

6.16 Set analog output (optional, only possible with the Enhanced version)

Parameter	Description
Signal	Select the desired signal which is to be performed on the analog output
Used output	Select the output, at which the desired signal is to be performed
min reference	Set the minimum signal level
max reference	Set the maximum signal level
min interface	Set the minimum desired output signal level (correspond to the output signal level at "min Interface")
max interface	Set the maximum desired output signal level (correspond to the output signal level at "max Interface")

6.17 Set enable channel

Parameter	Description
Enable	Selection, if the channel is constantly enabled (selection "on"), constantly disabled (selection "off") or if it depends on a digital input (selection "external")
Dig. input	If the parameter "Enable" is set to "external", the corresponding digital input can be selected here (in the example "DigInp1")

6.18 Save parameters in a file (optional)

Select "File - Save as ..."



Enter the directory and file name, afterwards select "OK"

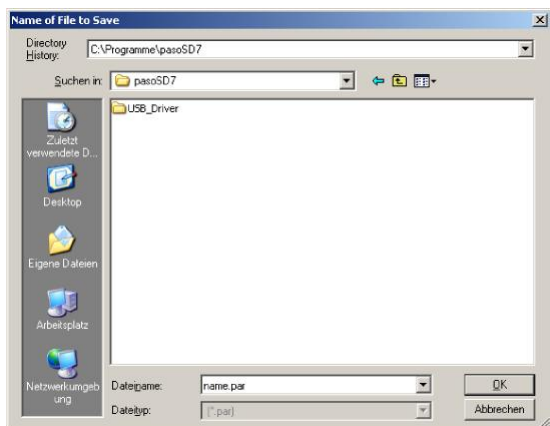

If required, enter the corresponding values to "Operator" and "Remarks", afterwards select "OK"

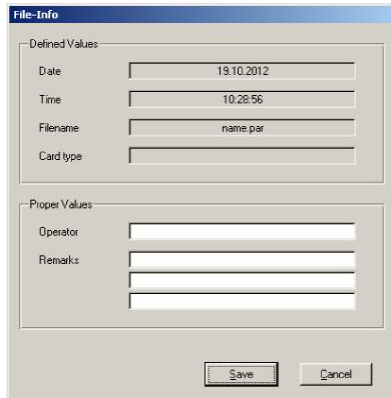

In the header line the corresponding file name appears

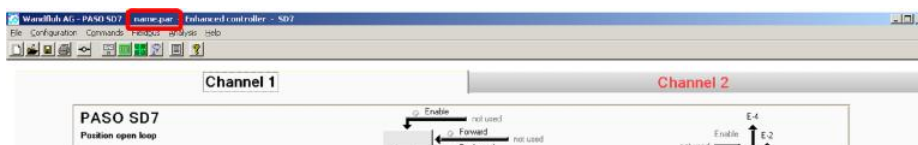

6.19 Activate PASO On Line mode

Select "File - Activate On Line"

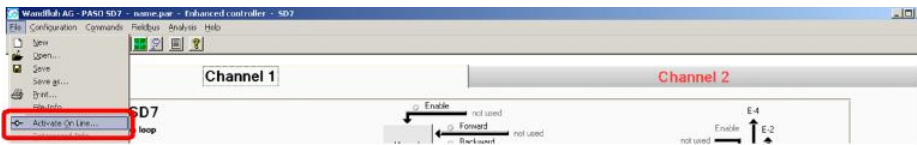

Select "Program the Wandfluh-Electronic with the new actual data?"

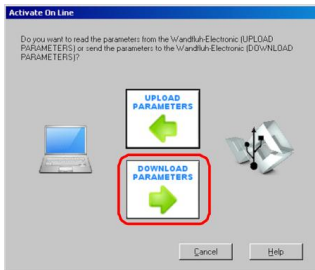

Select "OK"

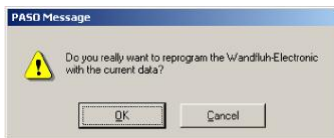

Select "OK"

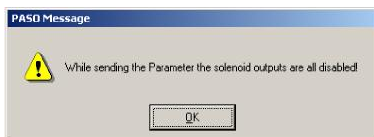

Wait, until all parameters are sent to the MD2 Electronics

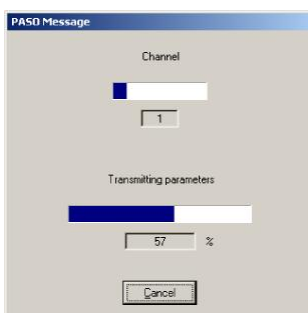

In the status line the message "On-Line" appears



7 Setup Instruction Speed control closed loop (2-sol)

7.1 Introduction

This guide shows with an example how to set channel 1 of the SD7 Electronics as a speed controller.

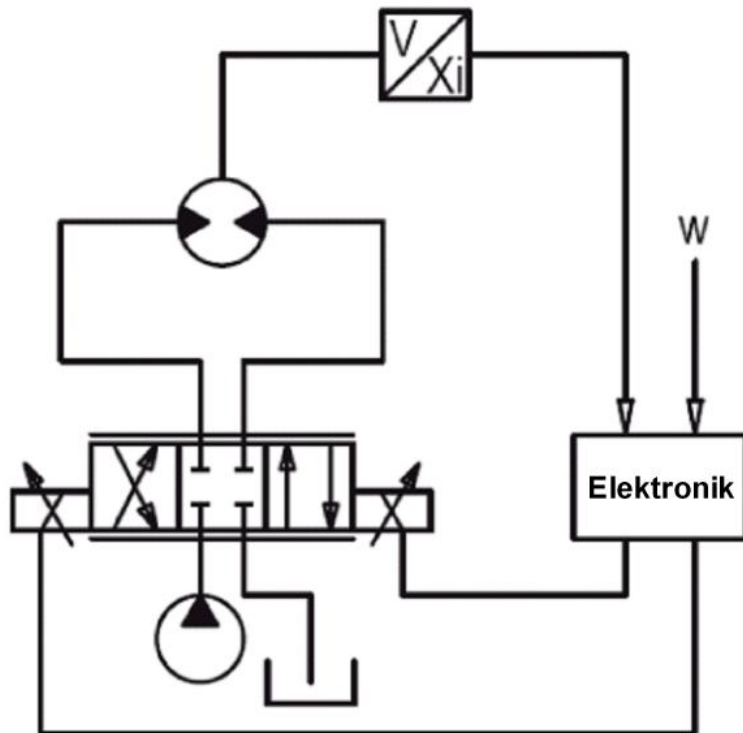

Pretended:

Controller mode: Speed control closed loop (2-sol)

Command signal: 0 ... 10V on analog input 1

Feedback signal: 0 ... 10V on analog input 2

max. working stroke: 0 ... 20l/min

desired working 2 ... 18l/min

stroke:

Valve connection: 4/3-way proportional valve, solenoid A = direction right, solenoid B = direction left

Enable channel: external via digital input 1

The following steps are necessary (steps with the remark "optional" are only necessary if needed):

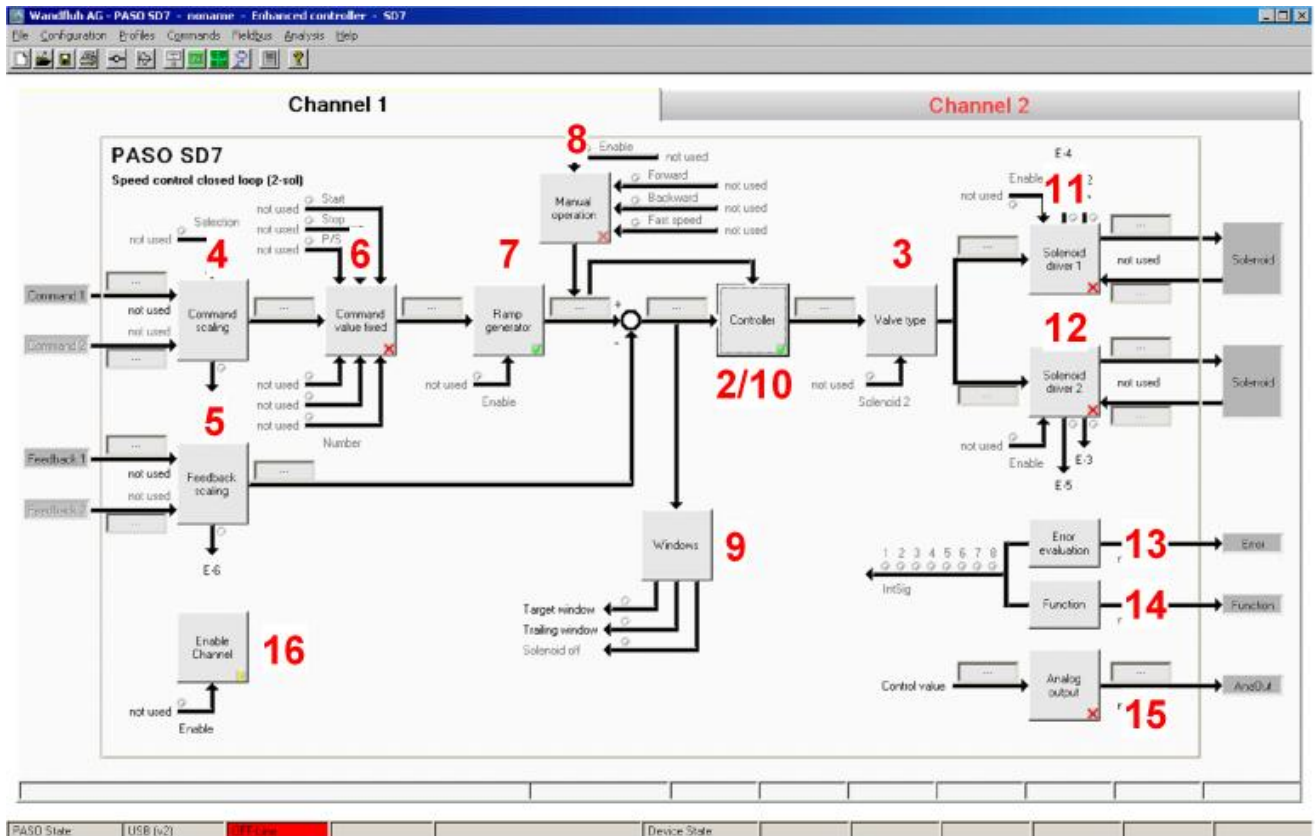

1. [Activate PASO Off Line mode](#) ⁵¹
2. [Select controller mode](#) ⁵¹
3. [Select valve type](#) ⁵¹
4. [Scale command signal](#) ⁵¹
5. [Scale feedback signal](#) ⁵²
6. [Set command values fixed](#) ⁵² (optional)
7. [Set speed](#) ⁵³
8. [Set manual operation](#) ⁵³ (optional)
9. [Set windows](#) ⁵³
10. [Set controller](#) ⁵⁴
11. [Set solenoid driver 1](#) ⁵⁴
12. [Set solenoid driver 2](#) ⁵⁵
13. [Set error evaluation](#) ⁵⁵ (optional)
14. [Set function](#) ⁵⁵ (optional)
15. [Set analog output](#) ⁵⁵ (optional, only possible with the Enhanced version)
16. [Set enable channel](#) ⁵⁶
17. [Save parameters in a file](#) ⁵⁷ (optional)
18. [Activate PASO On Line mode](#) ⁵⁸
19. By activating the digital input 1, the channel 1 will be released in the controller mode "Speed control closed loop (2-sol)"

7.2 Activate PASO Off Line mode

Select "File - Activate Off Line"

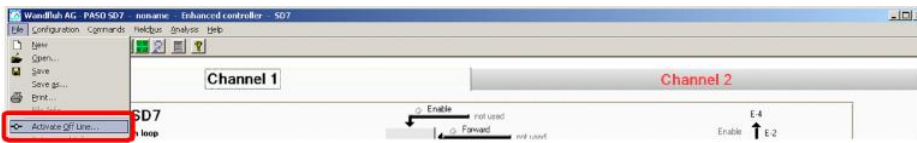

Select "OK"



In the status line the message "Off-Line" appears



7.3 Select controller mode

Parameter	Description
Controller mode	Select controller mode "Speed control closed loop (2-sol)
Displayed unit	Select the desired unit (in the example "l/min").

All other parameters in this window will be set later.

7.4 Select valve type

Parameter	Description
Solenoid type	Select the solenoid type of the connected valve (in the example "Proportional solenoid with current measurement")
Valve type	Select the valve type of the connected valve (in the example "Standard 2-solenoid")

The remaining parameters have no function in this control mode

7.5 Scale command signal

Parameter	Description
Signal type	Set the signal type from the command signal generator (in the example "Voltage")
Used analog input	If the parameter "Signal type" is set to "Voltage" or "Current", the input where the command signal generator is connect can be selected here (in the example "AnalInp1 [V]")
Used digital input	If the parameter "Signal type" is set to "Digital", "Frequency" or "PWM", the input where the command signal generator is connect can be selected here
Cablebreak detection	If the parameter "Signal type" is set to "Current", "Frequency" or "PWM", a cablebreak detection of the command signal generator can be activated
Lower cablebreak limit	If the parameter "Cablebreak detection" is set to "yes", the lower limit of this detection can be set here (command value < lower cablebreak limit = cablebreak)

Upper cablebreak limit	If the parameter "Cablebreak detection" is set to "yes", the upper limit of this detection can be set here (command value > upper cablebreak limit = cablebreak)
min interface	Set the minimum command signal level (in the example 0V)
max interface	Set the maximum command signal level (in the example 10V)
min reference	Set the minimum desired speed (correspond to the speed at "min interface", in the example 2l/min)
max reference	Set the maximum desired speed (correspond to the speed at "max interface", in the example 18l/min)
Function	Set the desired function for the second command signal input (in the example "not used")

The remaining parameters have no function in this control mode

7.6 Scale feedback signal

Parameter	Description
Signal type	Set the signal type from the feedback signal generator (in the example "Voltage")
Used analog input	If the parameter "Signal type" is set to "Voltage" or "Current", the input where the feedback signal generator is connect can be selected here (in the example "AnalInp2 [V]")
Used digital input	If the parameter "Signal type" is set to "Digital", "Frequency" or "PWM", the input where the feedback signal generator is connect can be selected here
Cablebreak detection	If the parameter "Signal type" is set to "Current", "Frequency" or "PWM", a cablebreak detection of the feedback signal generator can be activated
Lower cablebreak limit	If the parameter "Cablebreak detection" is set to "yes", the lower limit of this detection can be set here (feedback value < lower cablebreak limit = cablebreak)
Upper cablebreak limit	If the parameter "Cablebreak detection" is set to "yes", the upper limit of this detection can be set here (feedback value > upper cablebreak limit = cablebreak)
min interface	Set the minimum feedback signal level (correspond to the feedback signal level at "min reference", in the example 0V)
max interface	Set the maximum feedback signal level (correspond to the feedback signal level at "max reference", in the example 10V)
min reference	Set the minimum possible speed (in the example 0l/min)
max reference	Set the maximum possible speed (in the example 20l/min)
Function	Set the desired function for the second feedback signal input (in the example "not used")

7.7 Set command values fixed (optional)

Parameter	Description
Enable	Enable the fixed command value of the profile (only possible with the Enhanced function) function
Selection 1	Set the desired digital input for the fixed command value or profile 1
Selection 2	Set the desired digital input for the fixed command value or profile 2 and 3
Selection 4	Set the desired digital input for the fixed command value or profile 4, 5, 6 and 7
Fixed command value 1	Set the desired command value for the fixed command value 1. This value becomes the active command value if the digital from "Selection 1" is activated
Fixed command value 2	Set the desired command value for the fixed command value 2. This value becomes the active command value if the digital from "Selection 2" is activated
Fixed command value 3	Set the desired command value for the fixed command value 3. This value becomes the active command value if the digital from "Selection 1" and "Selection 2" are activated together
Fixed command value 4	Set the desired command value for the fixed command value 4. This value becomes the active command value if the digital from "Selection 3" is activated
Fixed command value 5	Set the desired command value for the fixed command value 5. This value becomes the active command value if the digital from "Selection 1" and "Selection 4" are activated together

Fixed command value 6	Set the desired command value for the fixed command value 6. This value becomes the active command value if the digital from "Selection 2" and "Selection 4" are activated together
Fixed command value 7	Set the desired command value for the fixed command value 7. This value becomes the active command value if the digital from "Selection 1", "Selection 2" and "Selection 4" are activated together
Selection 1	Set the desired profile number for the profile selection 1. This value becomes the active profile if the digital from "Selection 1" is activated
Selection 2	Set the desired profile number for the profile selection 2. This value becomes the active profile if the digital from "Selection 2" is activated
Selection 3	Set the desired profile number for the profile selection 3. This value becomes the active profile if the digital from "Selection 1" and "Selection 2" are activated together
Selection 4	Set the desired profile number for the profile selection 4. This value becomes the active profile if the digital from "Selection 3" is activated
Selection 5	Set the desired profile number for the profile selection 5. This value becomes the active profile if the digital from "Selection 1" and "Selection 4" are activated together
Selection 6	Set the desired profile number for the profile selection 6. This value becomes the active profile if the digital from "Selection 2" and "Selection 4" are activated together
Selection 7	Set the desired profile number for the profile selection 7. This value becomes the active profile if the digital from "Selection 1", "Selection 2" and "Selection 4" are activated together

7.8 Set speed

Parameter	Description
Speed +	This will set the speed rise speed of the system (speed rise = positive control deviation => command > feedback)
Speed -	This will set the speed reducing speed of the system (speed reducing = negative control deviation => command < feedback)
Acceleration +	This will set the speed rise acceleration of the system (speed rise = positive control deviation => command > feedback)
Acceleration -	This will set the speed reducing acceleration of the system (speed reducing = negative control deviation => command < feedback)
Deceleration +	This will set the speed rise deceleration of the system (speed rise = positive control deviation => command > feedback)
Deceleration -	This will set the speed reducing deceleration of the system (speed reducing = negative control deviation => command < feedback)

7.9 Set manual operation (optional)

Parameter	Description
Enable	Switch on / off the manual operation
Forward	Digital input for activating the forward function
Backward	Digital input for activating the backward function
Fast speed	Digital input for activating the fast speed
Slow speed	This will set the speed for the slow speed function (slow speed = digital input "Fast speed" not active)
Fast speed	This will set the speed for the fast speed function (fast speed = digital input "Fast speed" active)

7.10 Set windows

Parameter	Description
Target window type	Switch on/off the target window function
Target window threshold	Defines the target window range (control deviation < target window threshold = target window reached)
Target window delay time	Delay time when falling below and exceeding the target window threshold

Trailing window type	Switch on/off the trailing window function ATTENTION: With "on with error", the solenoid outputs will be disabled as soon as the trailing window is active!
Trailing window threshold	Defines the trailing window range (control deviation < trailing window threshold = trailing window reached)
Trailing window delay time	Delay time when falling below and exceeding the trailing window threshold
Solenoid-Off window type	Switch on/off the Solenoid-Off window function
Solenoid-Off window threshold	Defines the Solenoid-Off window range (control deviation < Solenoid-Off window threshold = solenoid are blocked)
Solenoid-Off window delay time	Delay time when falling below and exceeding the Solenoid-Off window threshold

In this control mode, the "Solenoid-Off" window must be set to "off".

7.11 Set controller

General

Parameter	Description
Command feed forward	The command value is multiplied with this factor and added to the correcting variable of the controller. If this factor is 0, no command value proportion is added to the correcting variable. Ideally, this value is set so that the deviation in the open loop is as small as possible. The deviation will not have the same size over the whole range. Thus, the smallest possible deviation can be set in the area where one will be mainly operate.
Velocity feed forward	In this control mode, this parameter must be set to 0

PID-controller

Using the parameters of the PID controller the control behavior can be set. Because the speed control is a dynamic control, the I-part can be omitted in many cases.

7.12 Set solenoid driver 1

Parameter	Description
Solenoid output	Select the output, where the solenoid for the right turning is connected (in the example "SolOutA")
Enable	Selection, if the solenoid output is constantly enabled (selection "on"), constantly disabled (selection "off") or if it depends on a digital input (selection "external")
Dig. input	If the parameter "Enable" is set to "external", the corresponding digital input can be selected here
Inversion	If a solenoid with a inverse function is used, this selection should be "yes", otherwise "no"
Solenoid always active	In this control mode, this parameter must always be set to "no"
Cablebreak detection	If the cablebreak detection for the solenoid output is desired, this selection should be "yes", otherwise "no"
Characteristic optimisation	If the characteristic optimisation is desired, this selection should be "yes", otherwise "no". (the settings for the characteristic optimisation is made in the Tab-window "Characteristic optimisation")
Imin	Set the desired minimum current for solenoid A. The Imin should set in the way that with this value the desired minimum speed will be reached
Imax	Set the desired maximum current for solenoid A. The Imax should be approx. the nominal current from the solenoid +5%
Dither function	The dither function should be activated (Selection "on")
Dither frequency	Set the desired dither frequency value
Dither level	Set the desired dither level value

The remaining parameters have no function in this control mode

7.13 Set solenoid driver 2

Parameter	Description
Solenoid output	Select the output, where the solenoid for the left turning is connected (in the example "SolOutB")
Enable	Selection, if the solenoid output is constantly enabled (selection "on"), constantly disabled (selection "off") or if it depends on a digital input (selection "external")
Dig. input	If the parameter "Enable" is set to "external", the corresponding digital input can be selected here
Inversion	If a solenoid with a inverse function is used, this selection should be "yes", otherwise "no"
Solenoid always active	In this control mode, this parameter must always be set to "no"
Cablebreak detection	If the cablebreak detection for the solenoid output is desired, this selection should be "yes", otherwise "no"
Characteristic optimisation	If the characteristic optimisation is desired, this selection should be "yes", otherwise "no". (the settings for the characteristic optimisation is made in the Tab-window "Characteristic optimisation")
Imin	Set the desired minimum current for solenoid A. The Imin should set in the way that with this value the desired minimum speed will be reached
Imax	Set the desired maximum current for solenoid A. The Imax should be approx. the nominal current from the solenoid +5%
Dither function	The dither function should be activated (Selection "on")
Dither frequency	Set the desired dither frequency value
Dither level	Set the desired dither level value

The remaining parameters have no function in this control mode

7.14 Set error evaluation (optional)

Parameter	Description
Selection	Here one can choose what error should activate the selected digital output
Dig. output	As soon as one of the selected error occurs, the selected digital output will be activated
Error action	With error "Cablebreak command signal" and "Cablebreak feedback signal", the desired error action can be set. The default setting is "Solenoid 1 + 2 off"

7.15 Set function (optional)

Parameter	Description
Selection	Here one can choose what function should activate the selected digital output

7.16 Set analog output (optional, only possible with the Enhanced version)

Parameter	Description
Signal	Select the desired signal which is to be performed on the analog output
Used output	Select the output, at which the desired signal is to be performed
min reference	Set the minimum signal level
max reference	Set the maximum signal level
min interface	Set the minimum desired output signal level (correspond to the output signal level at "min Interface")
max interface	Set the maximum desired output signal level (correspond to the output signal level at

	"max Interface")
--	------------------

7.17 Set enable channel

Parameter	Description
Enable	Selection, if the channel is constantly enabled (selection "on"), constantly disabled (selection "off") or if it depends on a digital input (selection "external")
Dig. input	If the parameter "Enable" is set to *external", the corresponding digital input can be selected here (in the example "DigInp1")

7.18 Save parameters in a file (optional)

Select "File - Save as ..."



Enter the directory and file name, afterwards select "OK"

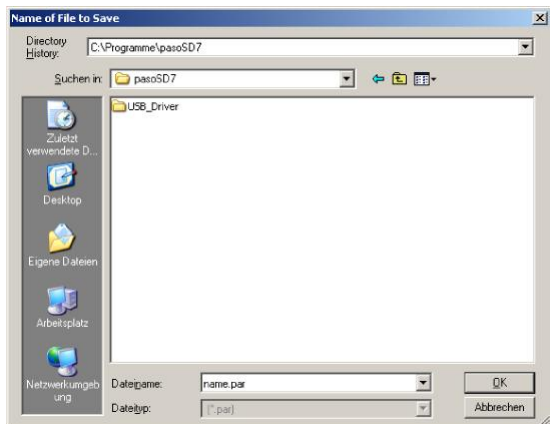

If required, enter the corresponding values to "Operator" and "Remarks", afterwards select "OK"

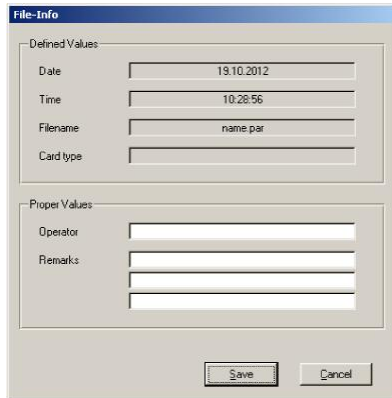

In the header line the corresponding file name appears

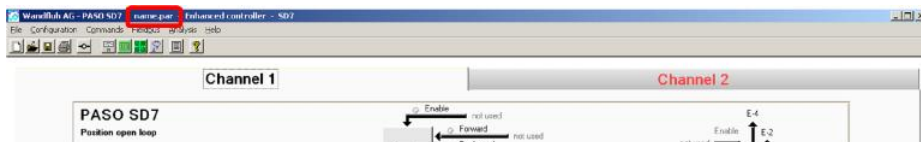

7.19 Activate PASO On Line mode

Select "File - Activate On Line"

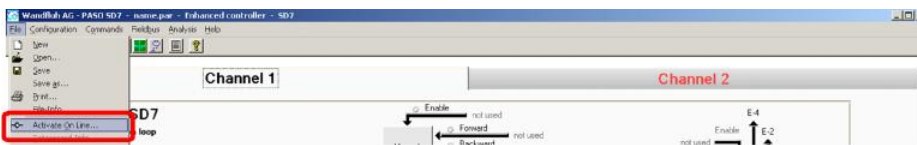

Select "Program the Wandfluh-Electronic with the new actual data?"

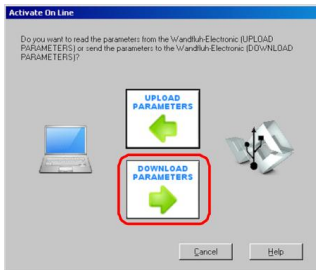

Select "OK"

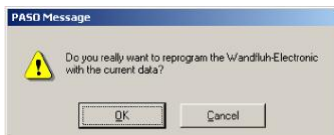

Select "OK"

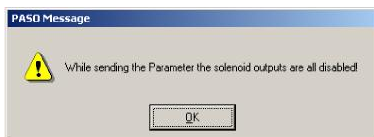

Wait, until all parameters are sent to the MD2 Electronics

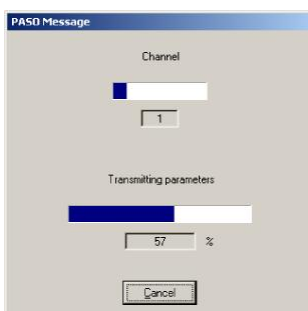

In the status line the message "On-Line" appears



8 Setup Instruction 2-point controller (1-sol)

8.1 Introduction

This guide shows with an example how to set channel 1 of the SD7 Electronics as a 1-point controller (1-solenoid).

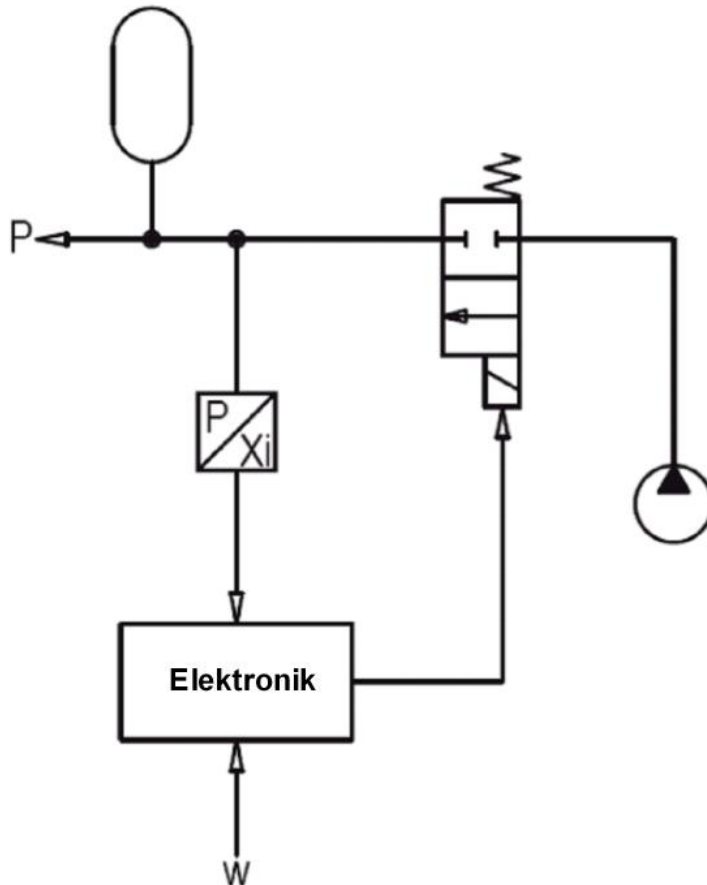

Pretended:

Controller mode: 2-point controller (1-sol)

Command signal: 0 ... 10V on analog input 1

Feedback signal: 0 ... 10V on analog input 2

max. working stroke: 0 ... 200bar

desired working 0 ... 200bar

stroke:

Control behavior: $p <$ command pressure, accumulator need to be charged

Valve connection: solenoid A = 2/2-way switching valve for charging the accumulator

Enable channel: external via digital input 1

The following steps are necessary (steps with the remark "optional" are only necessary if needed):

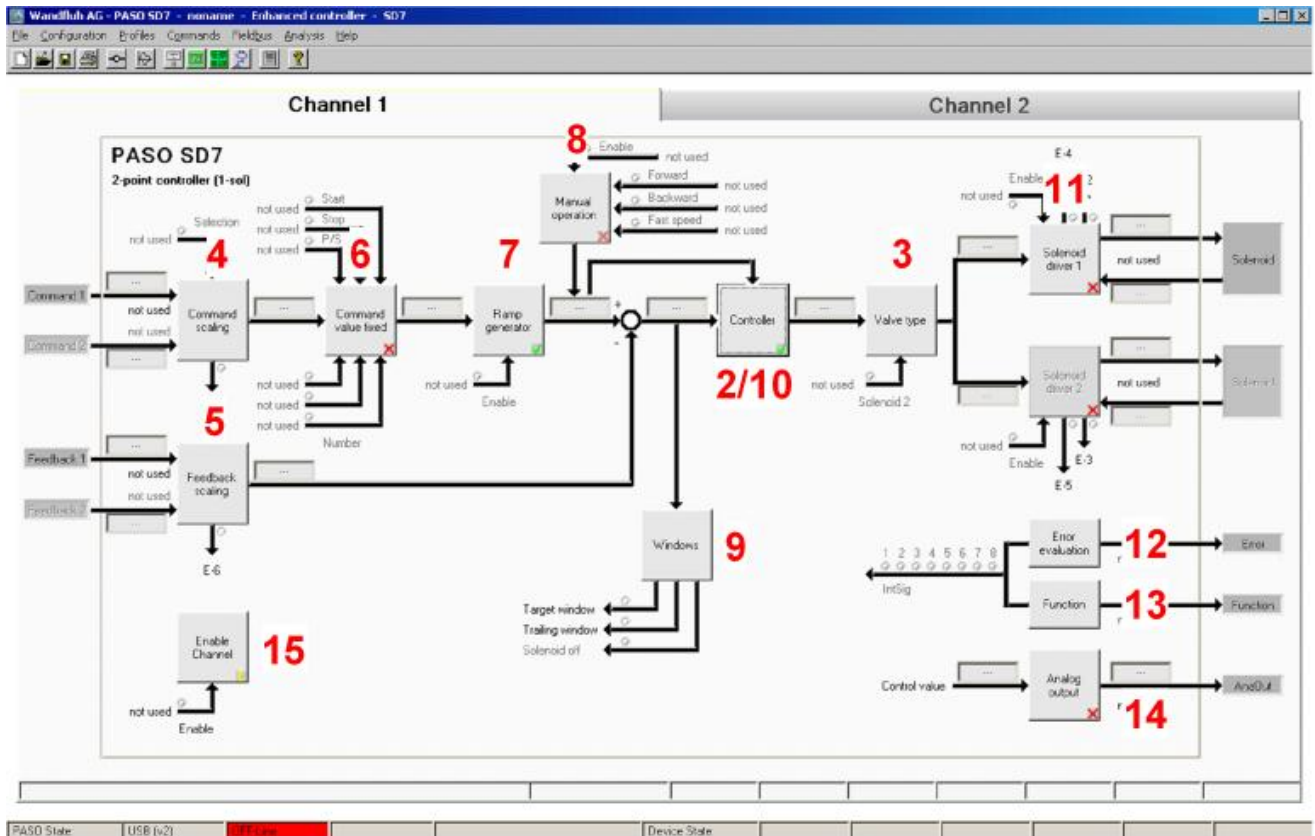

1. [Activate PASO Off Line mode](#) ^[61]
2. [Select controller mode](#) ^[61]
3. [Select valve type](#) ^[61]
4. [Scale command signal](#) ^[61]
5. [Scale feedback signal](#) ^[62]
6. [Set command values fixed](#) ^[62] (optional)
7. [Set speed](#) ^[63]
8. [Set manual operation](#) ^[43] (optional)
9. [Set windows](#) ^[63]
10. [Set controller](#) ^[64]
11. [Set solenoid driver 1](#) ^[64]
12. [Set error evaluation](#) ^[64] (optional)
13. [Set function](#) ^[65] (optional)
14. [Set analog output](#) ^[45] (optional, only possible with the Enhanced version)
15. [Set enable channel](#) ^[65]
16. [Save parameters in a file](#) ^[66] (optional)
17. [Activate PASO On Line mode](#) ^[67]
18. By activating the digital input 1, the channel 1 will be released in the controller mode "2-point controller (1-sol)"

8.2 Activate PASO Off Line mode

Select "File - Activate Off Line"

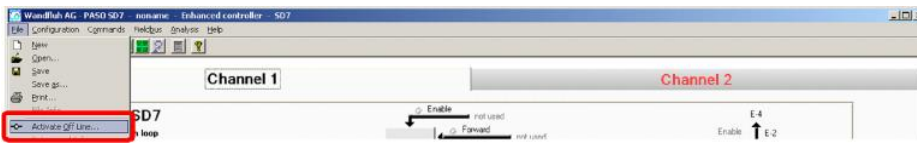

Select "OK"



In the status line the message "Off-Line" appears



8.3 Select controller mode

Parameter	Description
Controller mode	Select controller mode "2-point controller (1-sol)"
Displayed unit	Select the desired unit (in the example "bar")

All other parameters in this window will be set later.

8.4 Select valve type

Parameter	Description
Solenoid type	Select the solenoid type of the connected valve (in the example "Proportional solenoid with current measurement")
Valve type	Select the valve type of the connected valve (in the example "Standard 2-solenoid")

The remaining parameters have no function in this control mode

8.5 Scale command signal

Parameter	Description
Signal type	Set the signal type from the command signal generator (in the example "Voltage")
Used analog input	If the parameter "Signal type" is set to "Voltage" or "Current", the input where the command signal generator is connect can be selected here (in the example "AnalInp1 [V]")
Used digital input	If the parameter "Signal type" is set to "Digital", "Frequency" or "PWM", the input where the command signal generator is connect can be selected here
Cablebreak detection	If the parameter "Signal type" is set to "Current", "Frequency" or "PWM", a cablebreak detection of the command signal generator can be activated
Lower cablebreak limit	If the parameter "Cablebreak detection" is set to "yes", the lower limit of this detection can be set here (command value < lower cablebreak limit = cablebreak)

Upper cablebreak limit	If the parameter "Cablebreak detection" is set to "yes", the upper limit of this detection can be set here (command value > upper cablebreak limit = cablebreak)
min interface	Set the minimum command signal level (in the example 0V)
max interface	Set the maximum command signal level (in the example 10V)
min reference	Set the minimum desired pressure (correspond to the pressure at "min interface", in the example 0°C)
max reference	Set the maximum desired pressure (correspond to the pressure at "max interface", in the example 50°C)
Function	Set the desired function for the second command signal input (in the example "not used")

The remaining parameters have no function in this control mode

8.6 Scale feedback signal

Parameter	Description
Signal type	Set the signal type from the feedback signal generator (in the example "Voltage")
Used analog input	If the parameter "Signal type" is set to "Voltage" or "Current", the input where the feedback signal generator is connect can be selected here (in the example "AnalIn2 [V]")
Used digital input	If the parameter "Signal type" is set to "Digital", "Frequency" or "PWM", the input where the feedback signal generator is connect can be selected here
Cablebreak detection	If the parameter "Signal type" is set to "Current", "Frequency" or "PWM", a cablebreak detection of the feedback signal generator can be activated
Lower cablebreak limit	If the parameter "Cablebreak detection" is set to "yes", the lower limit of this detection can be set here (feedback value < lower cablebreak limit = cablebreak)
Upper cablebreak limit	If the parameter "Cablebreak detection" is set to "yes", the upper limit of this detection can be set here (feedback value > upper cablebreak limit = cablebreak)
min interface	Set the minimum feedback signal level (correspond to the feedback signal level at "min reference", in the example 0V)
max interface	Set the maximum feedback signal level (correspond to the feedback signal level at "max reference", in the example 10V)
min reference	Set the minimum possible pressure (in the example 0bar)
max reference	Set the maximum possible pressure (in the example 200bar)
Function	Set the desired function for the second feedback signal input (in the example "not used")

8.7 Set command values fixed (optional)

Parameter	Description
Enable	Enable the fixed command value of the profile (only possible with the Enhanced function) function
Selection 1	Set the desired digital input for the fixed command value or profile 1
Selection 2	Set the desired digital input for the fixed command value or profile 2 and 3
Selection 4	Set the desired digital input for the fixed command value or profile 4, 5, 6 and 7
Fixed command value 1	Set the desired command value for the fixed command value 1. This value becomes the active command value if the digital from "Selection 1" is activated
Fixed command value 2	Set the desired command value for the fixed command value 2. This value becomes the active command value if the digital from "Selection 2" is activated
Fixed command value 3	Set the desired command value for the fixed command value 3. This value becomes the active command value if the digital from "Selection 1" and "Selection 2" are activated together
Fixed command value 4	Set the desired command value for the fixed command value 4. This value becomes the active command value if the digital from "Selection 3" is activated
Fixed command value 5	Set the desired command value for the fixed command value 5. This value becomes the active command value if the digital from "Selection 1" and "Selection 4" are activated together

Fixed command value 6	Set the desired command value for the fixed command value 6. This value becomes the active command value if the digital from "Selection 2" and "Selection 4" are activated together
Fixed command value 7	Set the desired command value for the fixed command value 7. This value becomes the active command value if the digital from "Selection 1", "Selection 2" and "Selection 4" are activated together
Selection 1	Set the desired profile number for the profile selection 1. This value becomes the active profile if the digital from "Selection 1" is activated
Selection 2	Set the desired profile number for the profile selection 2. This value becomes the active profile if the digital from "Selection 2" is activated
Selection 3	Set the desired profile number for the profile selection 3. This value becomes the active profile if the digital from "Selection 1" and "Selection 2" are activated together
Selection 4	Set the desired profile number for the profile selection 4. This value becomes the active profile if the digital from "Selection 3" is activated
Selection 5	Set the desired profile number for the profile selection 5. This value becomes the active profile if the digital from "Selection 1" and "Selection 4" are activated together
Selection 6	Set the desired profile number for the profile selection 6. This value becomes the active profile if the digital from "Selection 2" and "Selection 4" are activated together
Selection 7	Set the desired profile number for the profile selection 7. This value becomes the active profile if the digital from "Selection 1", "Selection 2" and "Selection 4" are activated together

8.8 Set speed

Parameter	Description
Speed +	This will set the pressure rise speed of the system (pressure rise = positive control deviation => command > feedback)
Speed -	This will set the pressure reducing speed of the system (pressure reducing = negative control deviation => command < feedback)
Acceleration +	This will set the pressure rise acceleration of the system (pressure rise = positive control deviation => command > feedback)
Acceleration -	This will set the pressure reducing acceleration of the system (pressure reducing = negative control deviation => command < feedback)
Deceleration +	This will set the pressure rise deceleration of the system (pressure rise = positive control deviation => command > feedback)
Deceleration -	This will set the pressure reducing deceleration of the system (pressure reducing = negative control deviation => command < feedback)

8.9 Set manual operation (optional)

Parameter	Description
Enable	Switch on / off the manual operation
Forward	Digital input for activating the forward function
Backward	Digital input for activating the backward function
Fast speed	Digital input for activating the fast speed
Slow speed	This will set the speed for the slow speed function (slow speed = digital input "Fast speed" not active)
Fast speed	This will set the speed for the fast speed function (fast speed = digital input "Fast speed" active)

8.10 Set windows

Parameter	Description
Target window type	Switch on/off the target window function
Target window threshold	Defines the target window range (control deviation < target window threshold = target window reached)
Target window delay time	Delay time when falling below and exceeding the target window threshold

Trailing window type	Switch on/off the trailing window function ATTENTION: With "on with error", the solenoid outputs will be disabled as soon as the trailing window is active!
Trailing window threshold	Defines the trailing window range (control deviation < trailing window threshold = trailing window reached)
Trailing window delay time	Delay time when falling below and exceeding the trailing window threshold
Solenoid-Off window type	Switch on/off the Solenoid-Off window function
Solenoid-Off window threshold	Defines the Solenoid-Off window range (control deviation < Solenoid-Off window threshold = solenoid are blocked)
Solenoid-Off window delay time	Delay time when falling below and exceeding the Solenoid-Off window threshold

8.11 Set controller

General

Parameter	Description
Command feed forward	In this control mode, this parameter must be set to 0
Velocity feed forward	In this control mode, this parameter must be set to 0

n-point controller

Parameter	Description
Threshold 1	Control deviation, at which the solenoid output from solenoid driver 1 will be set to 100% (with increasing control deviation)
Threshold 2	Control deviation, at which the solenoid output from solenoid driver 1 will be set to 0% (with decreasing control deviation)

8.12 Set solenoid driver 1

Parameter	Description
Solenoid output	Select the output, where the solenoid is connected (in the example "SolOutA")
Enable	Selection, if the solenoid output is constantly enabled (selection "on"), constantly disabled (selection "off") or if it depends on a digital input (selection "external")
Dig. input	If the parameter "Enable" is set to "external", the corresponding digital input can be selected here
Inversion	If a solenoid with a inverse function is used, this selection should be "yes", otherwise "no"
Cablebreak detection	If the cablebreak detection for the solenoid output is desired, this selection should be "yes", otherwise "no"
Characteristic optimisation	If the characteristic optimisation is desired, this selection should be "yes", otherwise "no". (the settings for the characteristic optimisation is made in the Tab-window "Characteristic optimisation")
Reduction time	If a power reduction on the solenoid output is desired, the time after the reduction will start can be set here. With a setting from "0ms", the power reduction is switched off.
Reduced value	If a power reduction on the solenoid output is desired, the value where the output will be reduced to can be set here. With a setting from "100%", the reduction is switched off.

The remaining parameters have no function in this control mode

8.13 Set error evaluation (optional)

Parameter	Description
-----------	-------------

Selection	Here one can choose what error should activate the selected digital output
Dig. output	As soon as one of the selected error occurs, the selected digital output will be activated
Error action	With error "Cablebreak command signal" and "Cablebreak feedback signal", the desired error action can be set. The default setting is "Solenoid 1 + 2 off"

8.14 Set function (optional)

Parameter	Description
Selection	Here one can choose what function should activate the selected digital output

8.15 Set analog output (optional, only possible with the Enhanced version)

Parameter	Description
Signal	Select the desired signal which is to be performed on the analog output
Used output	Select the output, at which the desired signal is to be performed
min reference	Set the minimum signal level
max reference	Set the maximum signal level
min interface	Set the minimum desired output signal level (correspond to the output signal level at "min Interface")
max interface	Set the maximum desired output signal level (correspond to the output signal level at "max Interface")

8.16 Set enable channel

Parameter	Description
Enable	Selection, if the channel is constantly enabled (selection "on"), constantly disabled (selection "off") or if it depends on a digital input (selection "external")
Dig. input	If the parameter "Enable" is set to *external", the corresponding digital input can be selected here (in the example "DigInp1")

8.17 Save parameters in a file (optional)

Select "File - Save as ..."

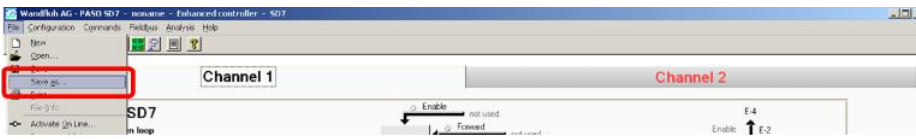

Enter the directory and file name, afterwards select "OK"

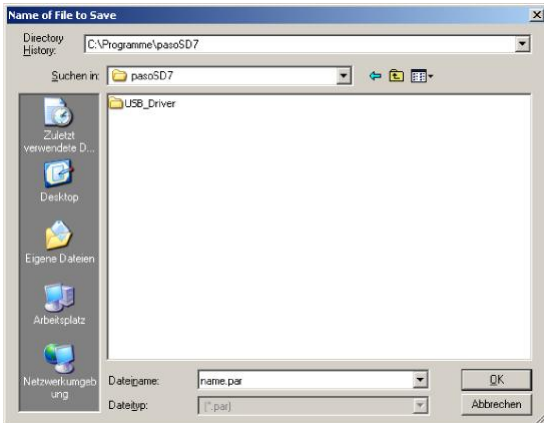

If required, enter the corresponding values to "Operator" and "Remarks", afterwards select "OK"

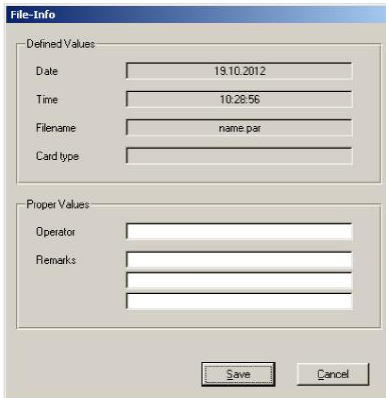

In the header line the corresponding file name appears

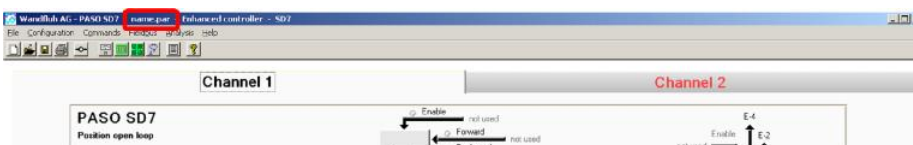

8.18 Activate PASO On Line mode

Select "File - Activate On Line"

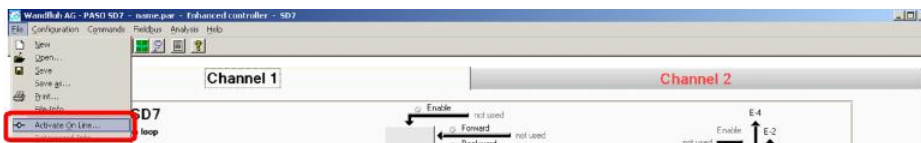

Select "Program the Wandfluh-Electronic with the new actual data?"

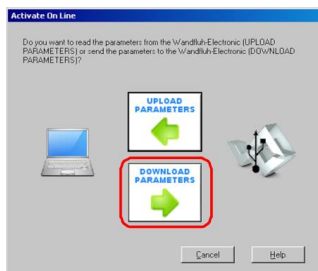

Select "OK"

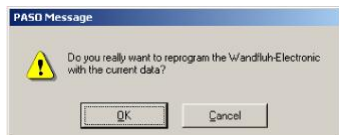

Select "OK"



Wait, until all parameters are sent to the MD2 Electronics

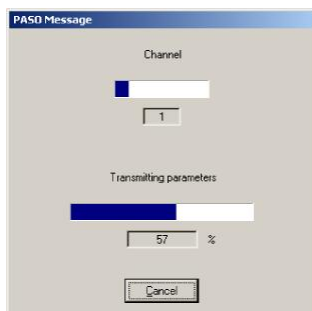

In the status line the message "On-Line" appears



9 Setup Instruction 2-point controller (2-sol)

9.1 Introduction

This guide shows with an example how to set channel 1 of the SD7 Electronics as a 2-point controller (2-solenoid).

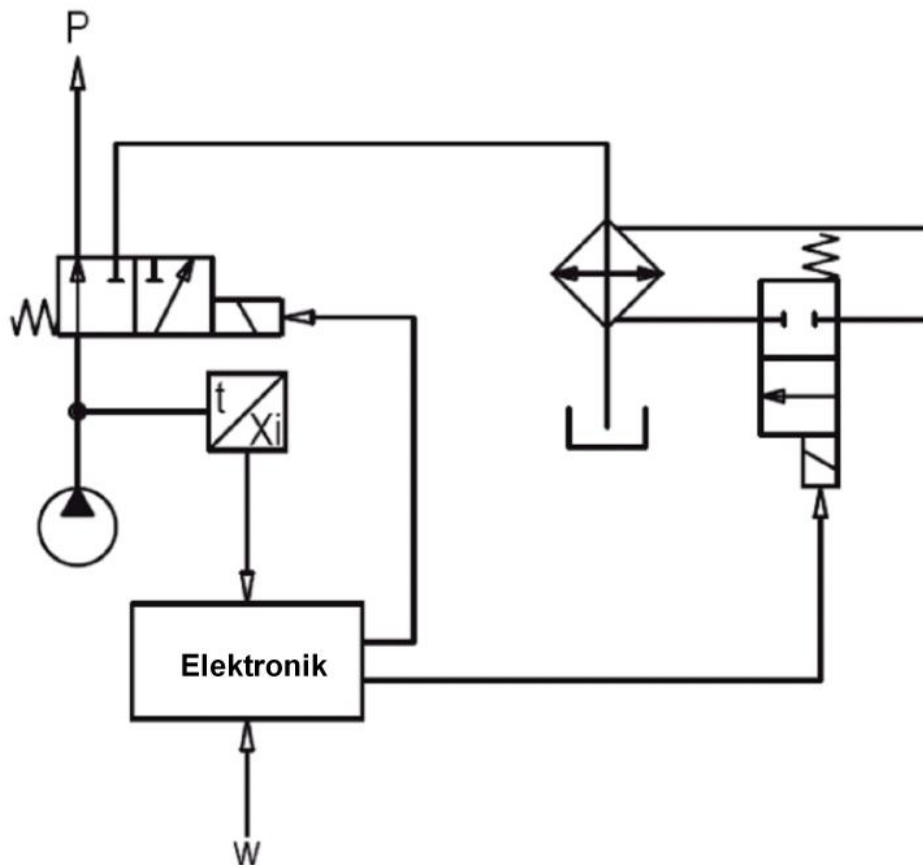

Pretended:

Controller mode: 2-point controller (2-sol)

Command signal: 0 ... 10V on analog input 1

Feedback signal: 0 ... 10V on analog input 2

max. working stroke: 0 ... 50°C

desired working stroke: 0 ... 50°C

stroke:

Control behavior: oil temperature < command temperature = oil to p
oil temperature >= command temperature = oil via cooler to tank, simultaneously switch on the cooling circuit

Valve connection: solenoid A = 3/2-way switching valve to switch oil to p - oil via cooler to tank

solenoid B = 2/2-way switching valve for switch on the cooling circuit

Enable channel: external via digital input 1

The following steps are necessary (steps with the remark "optional" are only necessary if needed):

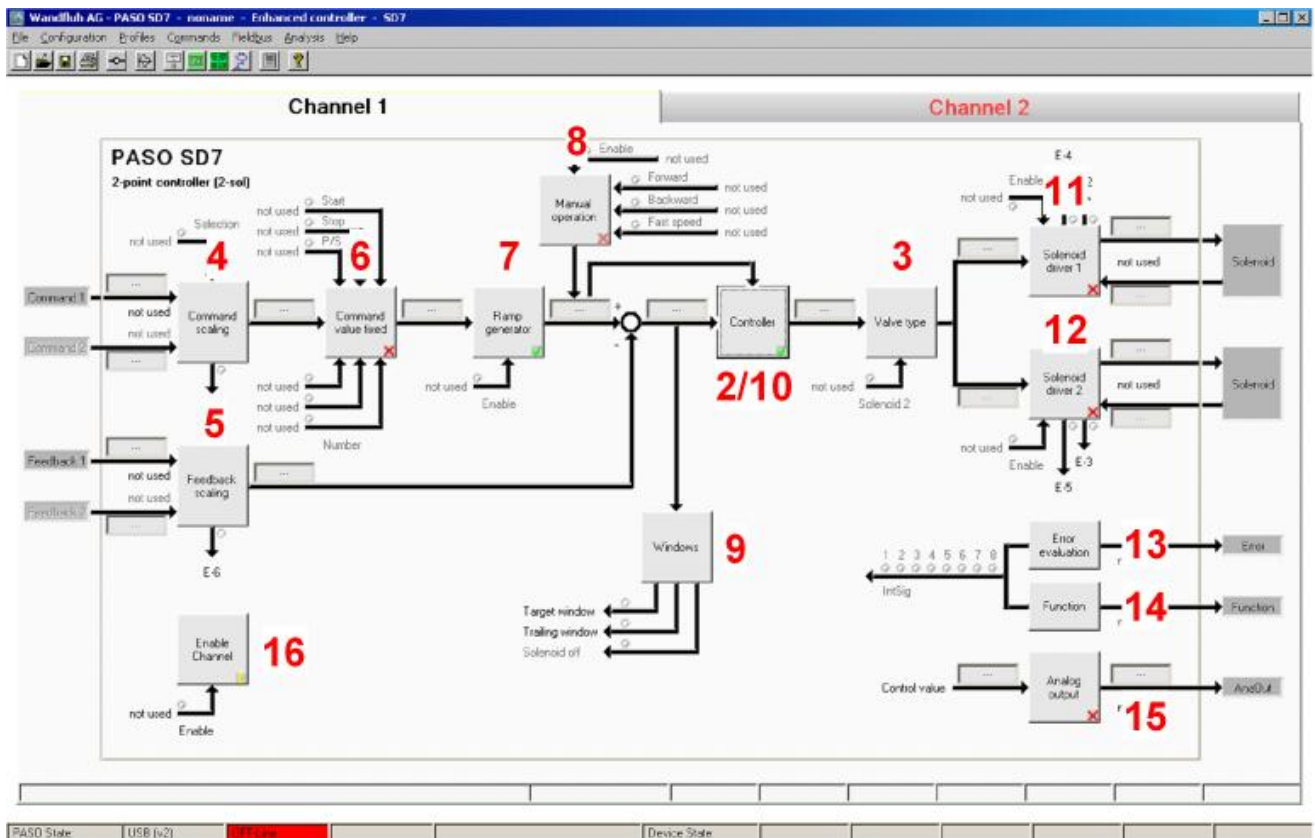

1. [Activate PASO Off Line mode](#) ^[70]
2. [Select controller mode](#) ^[70]
3. [Select valve type](#) ^[70]
4. [Scale command signal](#) ^[70]
5. [Scale feedback signal](#) ^[71]
6. [Set command values fixed](#) ^[71] (optional)
7. [Set speed](#) ^[72]
8. [Set manual operation](#) ^[43] (optional)
9. [Set windows](#) ^[72]
10. [Set controller](#) ^[73]
11. [Set solenoid driver 1](#) ^[73]
12. [Set solenoid driver 2](#) ^[74]
13. [Set error evaluation](#) ^[74] (optional)
14. [Set function](#) ^[74] (optional)
15. [Set analog output](#) ^[45] (optional, only possible with the Enhanced version)
16. [Set enable channel](#) ^[74]
17. [Save parameters in a file](#) ^[76] (optional)
18. [Activate PASO On Line mode](#) ^[77]
19. By activating the digital input 1, the channel 1 will be released in the controller mode "2-point controller (2-sol)"

9.2 Activate PASO Off Line mode

Select "File - Activate Off Line"

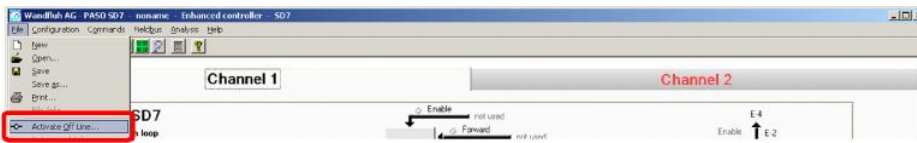

Select "OK"

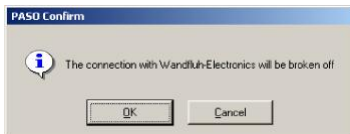

In the status line the message "Off-Line" appears



9.3 Select controller mode

Parameter	Description
Controller mode	Select controller mode "2-point controller (2-sol)"
Displayed unit	Select the desired unit (in the example "Free unit" and "°C")

All other parameters in this window will be set later.

9.4 Select valve type

Parameter	Description
Solenoid type	Select the solenoid type of the connected valve (in the example "Proportional solenoid with current measurement")
Valve type	Select the valve type of the connected valve (in the example "Standard 2-solenoid")

The remaining parameters have no function in this control mode

9.5 Scale command signal

Parameter	Description
Signal type	Set the signal type from the command signal generator (in the example "Voltage")
Used analog input	If the parameter "Signal type" is set to "Voltage" or "Current", the input where the command signal generator is connect can be selected here (in the example "AnalInp1 [V]")
Used digital input	If the parameter "Signal type" is set to "Digital", "Frequency" or "PWM", the input where the command signal generator is connect can be selected here
Cablebreak detection	If the parameter "Signal type" is set to "Current", "Frequency" or "PWM", a cablebreak detection of the command signal generator can be activated
Lower cablebreak limit	If the parameter "Cablebreak detection" is set to "yes", the lower limit of this detection can be set here (command value < lower cablebreak limit = cablebreak)

Upper cablebreak limit	If the parameter "Cablebreak detection" is set to "yes", the upper limit of this detection can be set here (command value > upper cablebreak limit = cablebreak)
min interface	Set the minimum command signal level (in the example 0V)
max interface	Set the maximum command signal level (in the example 10V)
min reference	Set the minimum desired temperature (correspond to the temperature at "min interface", in the example 0°C)
max reference	Set the maximum desired temperature (correspond to the temperature at "max interface", in the example 50°C)
Function	Set the desired function for the second command signal input (in the example "not used")

The remaining parameters have no function in this control mode

9.6 Scale feedback signal

Parameter	Description
Signal type	Set the signal type from the feedback signal generator (in the example "Voltage")
Used analog input	If the parameter "Signal type" is set to "Voltage" or "Current", the input where the feedback signal generator is connect can be selected here (in the example "AnalIn2 [V]")
Used digital input	If the parameter "Signal type" is set to "Digital", "Frequency" or "PWM", the input where the feedback signal generator is connect can be selected here
Cablebreak detection	If the parameter "Signal type" is set to "Current", "Frequency" or "PWM", a cablebreak detection of the feedback signal generator can be activated
Lower cablebreak limit	If the parameter "Cablebreak detection" is set to "yes", the lower limit of this detection can be set here (feedback value < lower cablebreak limit = cablebreak)
Upper cablebreak limit	If the parameter "Cablebreak detection" is set to "yes", the upper limit of this detection can be set here (feedback value > upper cablebreak limit = cablebreak)
min interface	Set the minimum feedback signal level (correspond to the feedback signal level at "min reference", in the example 0V)
max interface	Set the maximum feedback signal level (correspond to the feedback signal level at "max reference", in the example 10V)
min reference	Set the minimum possible temperature (in the example 0°C)
max reference	Set the maximum possible temperature (in the example 50°C)
Function	Set the desired function for the second feedback signal input (in the example "not used")

9.7 Set command values fixed (optional)

Parameter	Description
Enable	Enable the fixed command value of the profile (only possible with the Enhanced function) function
Selection 1	Set the desired digital input for the fixed command value or profile 1
Selection 2	Set the desired digital input for the fixed command value or profile 2 and 3
Selection 4	Set the desired digital input for the fixed command value or profile 4, 5, 6 and 7
Fixed command value 1	Set the desired command value for the fixed command value 1. This value becomes the active command value if the digital from "Selection 1" is activated
Fixed command value 2	Set the desired command value for the fixed command value 2. This value becomes the active command value if the digital from "Selection 2" is activated
Fixed command value 3	Set the desired command value for the fixed command value 3. This value becomes the active command value if the digital from "Selection 1" and "Selection 2" are activated together
Fixed command value 4	Set the desired command value for the fixed command value 4. This value becomes the active command value if the digital from "Selection 3" is activated
Fixed command value 5	Set the desired command value for the fixed command value 5. This value becomes the active command value if the digital from "Selection 1" and "Selection 4" are activated together

Fixed command value 6	Set the desired command value for the fixed command value 6. This value becomes the active command value if the digital from "Selection 2" and "Selection 4" are activated together
Fixed command value 7	Set the desired command value for the fixed command value 7. This value becomes the active command value if the digital from "Selection 1", "Selection 2" and "Selection 4" are activated together
Selection 1	Set the desired profile number for the profile selection 1. This value becomes the active profile if the digital from "Selection 1" is activated
Selection 2	Set the desired profile number for the profile selection 2. This value becomes the active profile if the digital from "Selection 2" is activated
Selection 3	Set the desired profile number for the profile selection 3. This value becomes the active profile if the digital from "Selection 1" and "Selection 2" are activated together
Selection 4	Set the desired profile number for the profile selection 4. This value becomes the active profile if the digital from "Selection 3" is activated
Selection 5	Set the desired profile number for the profile selection 5. This value becomes the active profile if the digital from "Selection 1" and "Selection 4" are activated together
Selection 6	Set the desired profile number for the profile selection 6. This value becomes the active profile if the digital from "Selection 2" and "Selection 4" are activated together
Selection 7	Set the desired profile number for the profile selection 7. This value becomes the active profile if the digital from "Selection 1", "Selection 2" and "Selection 4" are activated together

9.8 Set speed

Parameter	Description
Speed +	This will set the temperature rise speed of the system (temperature rise = positive control deviation => command > feedback)
Speed -	This will set the temperature reducing speed of the system (temperature reducing = negative control deviation => command < feedback)
Acceleration +	This will set the temperature rise acceleration of the system (temperature rise = positive control deviation => command > feedback)
Acceleration -	This will set the temperature reducing acceleration of the system (temperature reducing = negative control deviation => command < feedback)
Deceleration +	This will set the temperature rise deceleration of the system (temperature rise = positive control deviation => command > feedback)
Deceleration -	This will set the temperature reducing deceleration of the system (temperature reducing = negative control deviation => command < feedback)

9.9 Set manual operation (optional)

Parameter	Description
Enable	Switch on / off the manual operation
Forward	Digital input for activating the forward function
Backward	Digital input for activating the backward function
Fast speed	Digital input for activating the fast speed
Slow speed	This will set the speed for the slow speed function (slow speed = digital input "Fast speed" not active)
Fast speed	This will set the speed for the fast speed function (fast speed = digital input "Fast speed" active)

9.10 Set windows

Parameter	Description
Target window type	Switch on/off the target window function
Target window threshold	Defines the target window range (control deviation < target window threshold = target window reached)
Target window delay time	Delay time when falling below and exceeding the target window threshold

Trailing window type	Switch on/off the trailing window function ATTENTION: With "on with error", the solenoid outputs will be disabled as soon as the trailing window is active!
Trailing window threshold	Defines the trailing window range (control deviation < trailing window threshold = trailing window reached)
Trailing window delay time	Delay time when falling below and exceeding the trailing window threshold
Solenoid-Off window type	Switch on/off the Solenoid-Off window function
Solenoid-Off window threshold	Defines the Solenoid-Off window range (control deviation < Solenoid-Off window threshold = solenoid are blocked)
Solenoid-Off window delay time	Delay time when falling below and exceeding the Solenoid-Off window threshold

9.11 Set controller

General

Parameter	Description
Command feed forward	In this control mode, this parameter must be set to 0
Velocity feed forward	In this control mode, this parameter must be set to 0

n-point controller

Parameter	Description
Threshold 1	Control deviation, at which the solenoid output from solenoid driver 1 and solenoid driver 2 will be set to 100% (with increasing control deviation)
Threshold 2	Control deviation, at which the solenoid output from solenoid driver 1 and solenoid driver 1 will be set to 0% (with decreasing control deviation)

9.12 Set solenoid driver 1

Parameter	Description
Solenoid output	Select the output, where the solenoid for switch oil to p - oil via cooler to tank is connected (in the example "SolOutA")
Enable	Selection, if the solenoid output is constantly enabled (selection "on"), constantly disabled (selection "off") or if it depends on a digital input (selection "external")
Dig. input	If the parameter "Enable" is set to "external", the corresponding digital input can be selected here
Inversion	If a solenoid with a inverse function is used, this selection should be "yes", otherwise "no"
Cablebreak detection	If the cablebreak detection for the solenoid output is desired, this selection should be "yes", otherwise "no"
Characteristic optimisation	If the characteristic optimisation is desired, this selection should be "yes", otherwise "no". (the settings for the characteristic optimisation is made in the Tab-window "Characteristic optimisation")
Reduction time	If a power reduction on the solenoid output is desired, the time after the reduction will start can be set here. With a setting from "0ms", the power reduction is switched off.
Reduced value	If a power reduction on the solenoid output is desired, the value where the output will be reduced to can be set here. With a setting from "100%", the reduction is switched off.

The remaining parameters have no function in this control mode

9.13 Set solenoid driver 2

Parameter	Description
Solenoid output	Select the output, where the solenoid for the cooling system is connected (in the example "SolOutB")
Enable	Selection, if the solenoid output is constantly enabled (selection "on"), constantly disabled (selection "off") or if it depends on a digital input (selection "external")
Dig. input	If the parameter "Enable" is set to "external", the corresponding digital input can be selected here
Inversion	If a solenoid with a inverse function is used, this selection should be "yes", otherwise "no"
Cablebreak detection	If the cablebreak detection for the solenoid output is desired, this selection should be "yes", otherwise "no"
Characteristic optimisation	If the characteristic optimisation is desired, this selection should be "yes", otherwise "no". (the settings for the characteristic optimisation is made in the Tab-window "Characteristic optimisation")
Reduction time	If a power reduction on the solenoid output is desired, the time after the reduction will start can be set here. With a setting from "0ms", the power reduction is switched off.
Reduced value	If a power reduction on the solenoid output is desired, the value where the output will be reduced to can be set here. With a setting from "100%", the reduction is switched off.

The remaining parameters have no function in this control mode

9.14 Set error evaluation (optional)

Parameter	Description
Selection	Here one can choose what error should activate the selected digital output
Dig. output	As soon as one of the selected error occurs, the selected digital output will be activated
Error action	With error "Cablebreak command signal" and "Cablebreak feedback signal", the desired error action can be set. The default setting is "Solenoid 1 + 2 off"

9.15 Set function (optional)

Parameter	Description
Selection	Here one can choose what function should activate the selected digital output

9.16 Set analog output (optional, only possible with the Enhanced version)

Parameter	Description
Signal	Select the desired signal which is to be performed on the analog output
Used output	Select the output, at which the desired signal is to be performed
min reference	Set the minimum signal level
max reference	Set the maximum signal level
min interface	Set the minimum desired output signal level (correspond to the output signal level at "min Interface")
max interface	Set the maximum desired output signal level (correspond to the output signal level at "max Interface")

9.17 Set enable channel

Parameter	Description
Enable	Selection, if the channel is constantly enabled (selection "on"), constantly disabled (selection "off") or if it depends on a digital input (selection "external")

Dig. input	If the parameter "Enable" is set to *external", the corresponding digital input can be selected here (in the example "DigInp1")
------------	---

9.18 Save parameters in a file (optional)

Select "File - Save as ..."



Enter the directory and file name, afterwards select "OK"

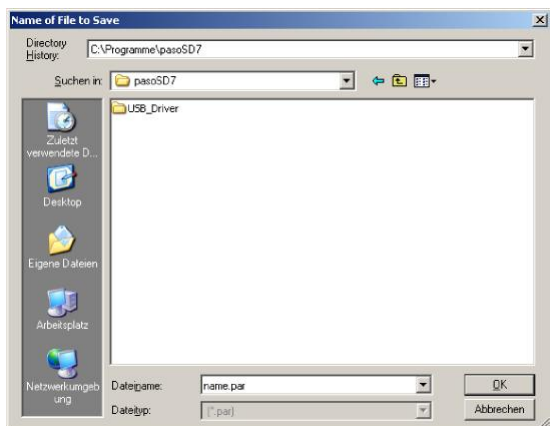

If required, enter the corresponding values to "Operator" and "Remarks", afterwards select "OK"

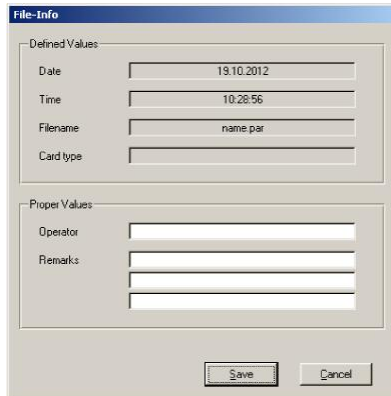

In the header line the corresponding file name appears

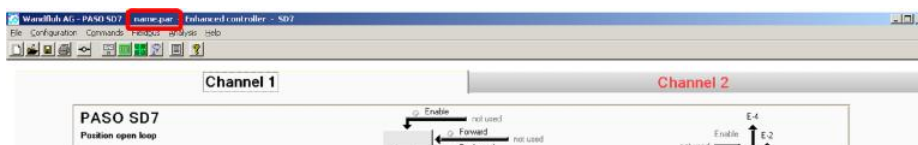

9.19 Activate PASO On Line mode

Select "File - Activate On Line"

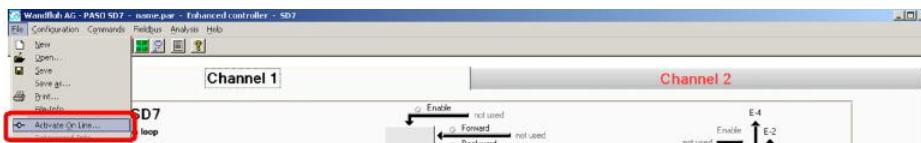

Select "Program the Wandfluh-Electronic with the new actual data?"

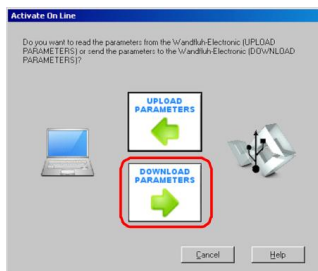

Select "OK"

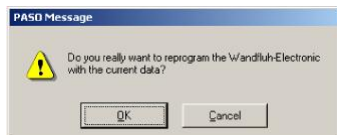

Select "OK"



Wait, until all parameters are sent to the MD2 Electronics

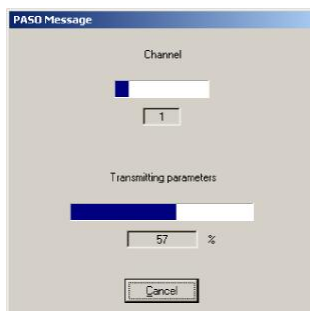

In the status line the message "On-Line" appears



10 Setup Instruction 3-point controller (2-sol)

10.1 Introduction

This guide shows with an example how to set channel 1 of the SD7 Electronics as a 3-point controller (2-solenoid).

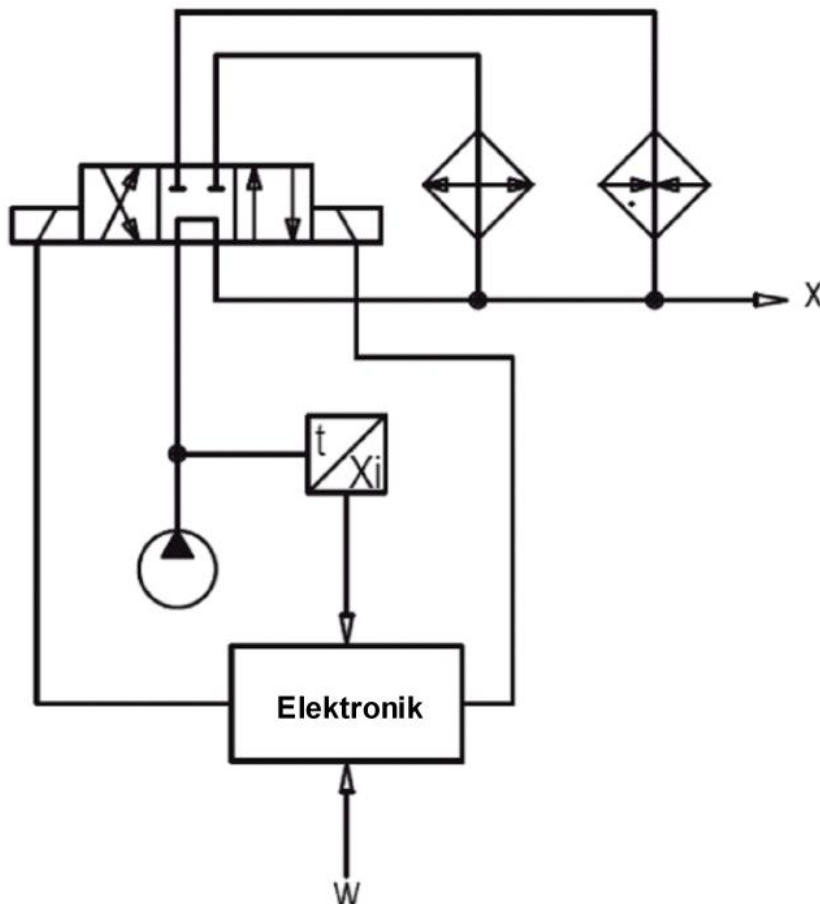

Pretended:

Controller mode: 3-point controller (2-sol)
 Command signal: 0 ... 10V on analog input 1
 Feedback signal: 0 ... 10V on analog input 2
 max. working stroke: 0 ... 50°C
 desired working stroke: 0 ... 50°C

Control behavior:
 oil temperature < command temperature - 5°C = oil via heating to x
 oil temperature > command temperature + 5°C = oil via cooler to x
 otherwise oil direct to x

Valve connection: 4/3-way switching valve, solenoid A for heating, solenoid B for cooling
 Enable channel: external via digital input 1

The following steps are necessary (steps with the remark "optional" are only necessary if needed):

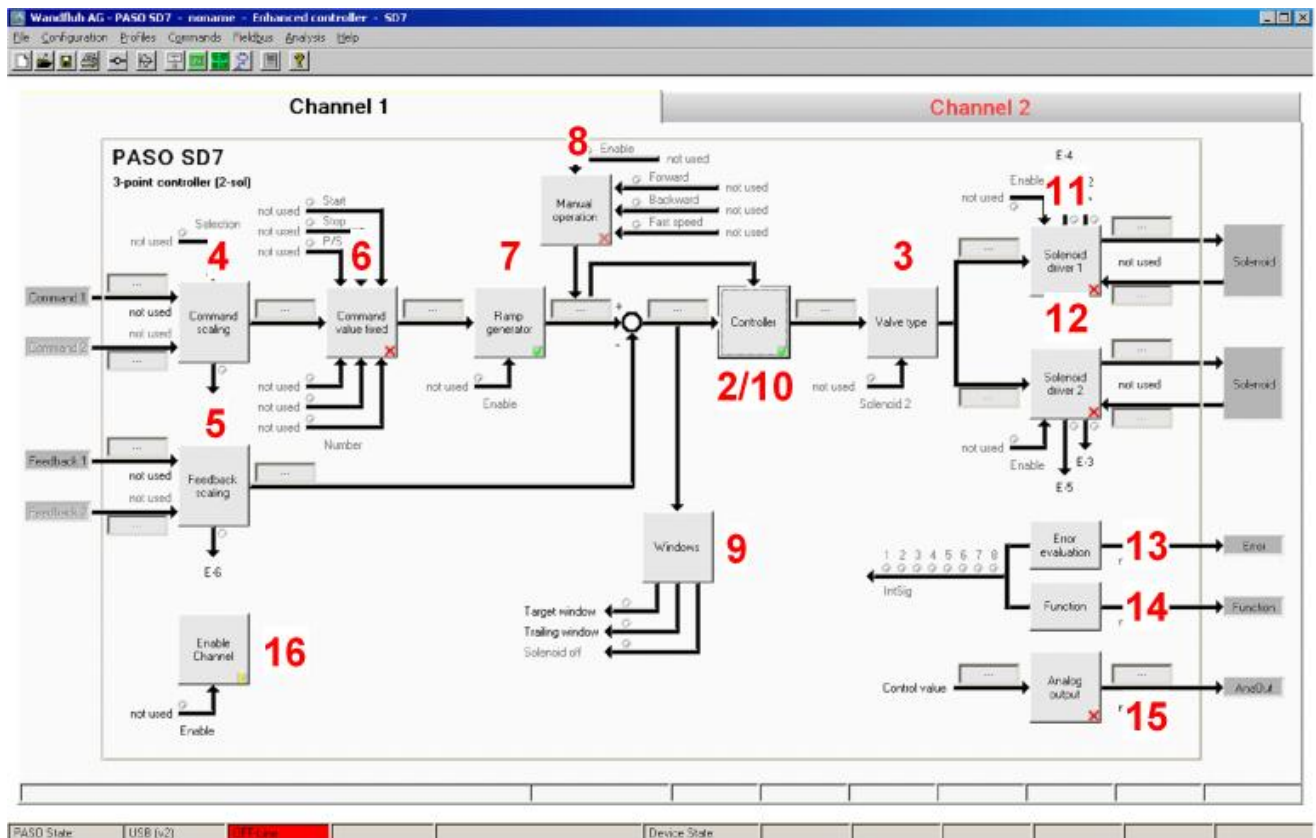

1. [Activate PASO Off Line mode](#) ⁸⁰
2. [Select controller mode](#) ⁸⁰
3. [Select valve type](#) ⁸⁰
4. [Scale command signal](#) ⁸⁰
5. [Scale feedback signal](#) ⁸¹
6. [Set command values fixed](#) ⁸¹ (optional)
7. [Set speed](#) ⁸²
8. [Set manual operation](#) ⁸² (optional)
9. [Set windows](#) ⁸²
10. [Set controller](#) ⁸³
11. [Set solenoid driver 1](#) ⁸³
12. [Set solenoid driver 2](#) ⁸⁴
13. [Set error evaluation](#) ⁸⁴ (optional)
14. [Set function](#) ⁸⁴ (optional)
15. [Set analog output](#) ⁸⁴ (optional, only possible with the Enhanced version)
16. [Set enable channel](#) ⁸⁴
17. [Save parameters in a file](#) ⁸⁶ (optional)
18. [Activate PASO On Line mode](#) ⁸⁷
19. By activating the digital input 1, the channel 1 will be released in the controller mode "3-point controller (2-sol)"

10.2 Activate PASO Off Line mode

Select "File - Activate Off Line"

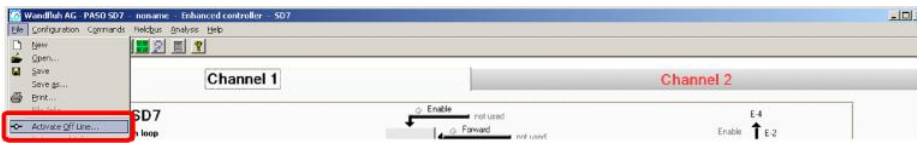

Select "OK"



In the status line the message "Off-Line" appears



10.3 Select controller mode

Parameter	Description
Controller mode	Select controller mode "3-point controller (2-sol)"
Displayed unit	Select the desired unit (in the example "Free unit" and "°C")

All other parameters in this window will be set later.

10.4 Select valve type

Parameter	Description
Solenoid type	Select the solenoid type of the connected valve (in the example "Proportional solenoid with current measurement")
Valve type	Select the valve type of the connected valve (in the example "Standard 2-solenoid")

The remaining parameters have no function in this control mode

10.5 Scale command signal

Parameter	Description
Signal type	Set the signal type from the command signal generator (in the example "Voltage")
Used analog input	If the parameter "Signal type" is set to "Voltage" or "Current", the input where the command signal generator is connect can be selected here (in the example "AnalInp1 [V]")
Used digital input	If the parameter "Signal type" is set to "Digital", "Frequency" or "PWM", the input where the command signal generator is connect can be selected here
Cablebreak detection	If the parameter "Signal type" is set to "Current", "Frequency" or "PWM", a cablebreak detection of the command signal generator can be activated
Lower cablebreak limit	If the parameter "Cablebreak detection" is set to "yes", the lower limit of this detection can be set here (command value < lower cablebreak limit = cablebreak)

Upper cablebreak limit	If the parameter "Cablebreak detection" is set to "yes", the upper limit of this detection can be set here (command value > upper cablebreak limit = cablebreak)
min interface	Set the minimum command signal level (in the example 0V)
max interface	Set the maximum command signal level (in the example 10V)
min reference	Set the minimum desired temperature (correspond to the temperature at "min interface", in the example 0°C)
max reference	Set the maximum desired temperature (correspond to the temperature at "max interface", in the example 50°C)
Function	Set the desired function for the second command signal input (in the example "not used")

The remaining parameters have no function in this control mode

10.6 Scale feedback signal

Parameter	Description
Signal type	Set the signal type from the feedback signal generator (in the example "Voltage")
Used analog input	If the parameter "Signal type" is set to "Voltage" or "Current", the input where the feedback signal generator is connect can be selected here (in the example "AnalIn2 [V]")
Used digital input	If the parameter "Signal type" is set to "Digital", "Frequency" or "PWM", the input where the feedback signal generator is connect can be selected here
Cablebreak detection	If the parameter "Signal type" is set to "Current", "Frequency" or "PWM", a cablebreak detection of the feedback signal generator can be activated
Lower cablebreak limit	If the parameter "Cablebreak detection" is set to "yes", the lower limit of this detection can be set here (feedback value < lower cablebreak limit = cablebreak)
Upper cablebreak limit	If the parameter "Cablebreak detection" is set to "yes", the upper limit of this detection can be set here (feedback value > upper cablebreak limit = cablebreak)
min interface	Set the minimum feedback signal level (correspond to the feedback signal level at "min reference", in the example 0V)
max interface	Set the maximum feedback signal level (correspond to the feedback signal level at "max reference", in the example 10V)
min reference	Set the minimum possible temperature (in the example 0°C)
max reference	Set the maximum possible temperature (in the example 50°C)
Function	Set the desired function for the second feedback signal input (in the example "not used")

10.7 Set command values fixed (optional)

Parameter	Description
Enable	Enable the fixed command value of the profile (only possible with the Enhanced function) function
Selection 1	Set the desired digital input for the fixed command value or profile 1
Selection 2	Set the desired digital input for the fixed command value or profile 2 and 3
Selection 4	Set the desired digital input for the fixed command value or profile 4, 5, 6 and 7
Fixed command value 1	Set the desired command value for the fixed command value 1. This value becomes the active command value if the digital from "Selection 1" is activated
Fixed command value 2	Set the desired command value for the fixed command value 2. This value becomes the active command value if the digital from "Selection 2" is activated
Fixed command value 3	Set the desired command value for the fixed command value 3. This value becomes the active command value if the digital from "Selection 1" and "Selection 2" are activated together
Fixed command value 4	Set the desired command value for the fixed command value 4. This value becomes the active command value if the digital from "Selection 3" is activated
Fixed command value 5	Set the desired command value for the fixed command value 5. This value becomes the active command value if the digital from "Selection 1" and "Selection 4" are activated together

Fixed command value 6	Set the desired command value for the fixed command value 6. This value becomes the active command value if the digital from "Selection 2" and "Selection 4" are activated together
Fixed command value 7	Set the desired command value for the fixed command value 7. This value becomes the active command value if the digital from "Selection 1", "Selection 2" and "Selection 4" are activated together
Selection 1	Set the desired profile number for the profile selection 1. This value becomes the active profile if the digital from "Selection 1" is activated
Selection 2	Set the desired profile number for the profile selection 2. This value becomes the active profile if the digital from "Selection 2" is activated
Selection 3	Set the desired profile number for the profile selection 3. This value becomes the active profile if the digital from "Selection 1" and "Selection 2" are activated together
Selection 4	Set the desired profile number for the profile selection 4. This value becomes the active profile if the digital from "Selection 3" is activated
Selection 5	Set the desired profile number for the profile selection 5. This value becomes the active profile if the digital from "Selection 1" and "Selection 4" are activated together
Selection 6	Set the desired profile number for the profile selection 6. This value becomes the active profile if the digital from "Selection 2" and "Selection 4" are activated together
Selection 7	Set the desired profile number for the profile selection 7. This value becomes the active profile if the digital from "Selection 1", "Selection 2" and "Selection 4" are activated together

10.8 Set speed

Parameter	Description
Speed +	This will set the temperature rise speed of the system (temperature rise = positive control deviation => command > feedback)
Speed -	This will set the temperature reducing speed of the system (temperature reducing = negative control deviation => command < feedback)
Acceleration +	This will set the temperature rise acceleration of the system (temperature rise = positive control deviation => command > feedback)
Acceleration -	This will set the temperature reducing acceleration of the system (temperature reducing = negative control deviation => command < feedback)
Deceleration +	This will set the temperature rise deceleration of the system (temperature rise = positive control deviation => command > feedback)
Deceleration -	This will set the temperature reducing deceleration of the system (temperature reducing = negative control deviation => command < feedback)

10.9 Set manual operation (optional)

Parameter	Description
Enable	Switch on / off the manual operation
Forward	Digital input for activating the forward function
Backward	Digital input for activating the backward function
Fast speed	Digital input for activating the fast speed
Slow speed	This will set the speed for the slow speed function (slow speed = digital input "Fast speed" not active)
Fast speed	This will set the speed for the fast speed function (fast speed = digital input "Fast speed" active)

10.10 Set windows

Parameter	Description
Target window type	Switch on/off the target window function
Target window threshold	Defines the target window range (control deviation < target window threshold = target window reached)
Target window delay time	Delay time when falling below and exceeding the target window threshold

Trailing window type	Switch on/off the trailing window function ATTENTION: With "on with error", the solenoid outputs will be disabled as soon as the trailing window is active!
Trailing window threshold	Defines the trailing window range (control deviation < trailing window threshold = trailing window reached)
Trailing window delay time	Delay time when falling below and exceeding the trailing window threshold
Solenoid-Off window type	Switch on/off the Solenoid-Off window function
Solenoid-Off window threshold	Defines the Solenoid-Off window range (control deviation < Solenoid-Off window threshold = solenoid are blocked)
Solenoid-Off window delay time	Delay time when falling below and exceeding the Solenoid-Off window threshold

10.11 Set controller

General

Parameter	Description
Command feed forward	In this control mode, this parameter must be set to 0
Velocity feed forward	In this control mode, this parameter must be set to 0

n-point controller

Parameter	Description
Threshold 1	Control deviation, at which the solenoid output from solenoid driver 1 will be set to 100% (with increasing control deviation)
Threshold 2	Control deviation, at which the solenoid output from solenoid driver 1 will be set to 0% (with decreasing control deviation)
Threshold 3	Control deviation, at which the solenoid output from solenoid driver 2 will be set to 100% (with decreasing control deviation)
Threshold 4	Control deviation, at which the solenoid output from solenoid driver 2 will be set to 0% (with increasing control deviation)

10.12 Set solenoid driver 1

Parameter	Description
Solenoid output	Select the output, where the solenoid for cooling is heating (in the example "SolOutA")
Enable	Selection, if the solenoid output is constantly enabled (selection "on"), constantly disabled (selection "off") or if it depends on a digital input (selection "external")
Dig. input	If the parameter "Enable" is set to "external", the corresponding digital input can be selected here
Inversion	If a solenoid with a inverse function is used, this selection should be "yes", otherwise "no"
Cablebreak detection	If the cablebreak detection for the solenoid output is desired, this selection should be "yes", otherwise "no"
Characteristic optimisation	If the characteristic optimisation is desired, this selection should be "yes", otherwise "no". (the settings for the characteristic optimisation is made in the Tab-window "Characteristic optimisation")
Reduction time	If a power reduction on the solenoid output is desired, the time after the reduction will start can be set here. With a setting from "0ms", the power reduction is switched off.
Reduced value	If a power reduction on the solenoid output is desired, the value where the output will be reduced to can be set here. With a setting from "100%", the reduction is switched off.

The remaining parameters have no function in this control mode

10.13 Set solenoid driver 2

Parameter	Description
Solenoid output	Select the output, where the solenoid for cooling is connected (in the example "SolOutB")
Enable	Selection, if the solenoid output is constantly enabled (selection "on"), constantly disabled (selection "off") or if it depends on a digital input (selection "external")
Dig. input	If the parameter "Enable" is set to "external", the corresponding digital input can be selected here
Inversion	If a solenoid with a inverse function is used, this selection should be "yes", otherwise "no"
Cablebreak detection	If the cablebreak detection for the solenoid output is desired, this selection should be "yes", otherwise "no"
Characteristic optimisation	If the characteristic optimisation is desired, this selection should be "yes", otherwise "no". (the settings for the characteristic optimisation is made in the Tab-window "Characteristic optimisation")
Reduction time	If a power reduction on the solenoid output is desired, the time after the reduction will start can be set here. With a setting from "0ms", the power reduction is switched off.
Reduced value	If a power reduction on the solenoid output is desired, the value where the output will be reduced to can be set here. With a setting from "100%", the reduction is switched off.

The remaining parameters have no function in this control mode

10.14 Set error evaluation (optional)

Parameter	Description
Selection	Here one can choose what error should activate the selected digital output
Dig. output	As soon as one of the selected error occurs, the selected digital output will be activated
Error action	With error "Cablebreak command signal" and "Cablebreak feedback signal", the desired error action can be set. The default setting is "Solenoid 1 + 2 off"

10.15 Set function (optional)

Parameter	Description
Selection	Here one can choose what function should activate the selected digital output

10.16 Set analog output (optional, only possible with the Enhanced version)

Parameter	Description
Signal	Select the desired signal which is to be performed on the analog output
Used output	Select the output, at which the desired signal is to be performed
min reference	Set the minimum signal level
max reference	Set the maximum signal level
min interface	Set the minimum desired output signal level (correspond to the output signal level at "min Interface")
max interface	Set the maximum desired output signal level (correspond to the output signal level at "max Interface")

10.17 Set enable channel

Parameter	Description
Enable	Selection, if the channel is constantly enabled (selection "on"), constantly disabled (selection "off") or if it depends on a digital input (selection "external")

Dig. input	If the parameter "Enable" is set to *external", the corresponding digital input can be selected here (in the example "DigInp1")
------------	---

10.18 Save parameters in a file (optional)

Select "File - Save as ..."

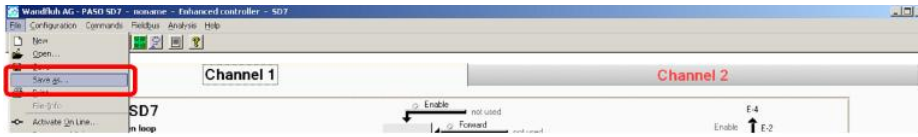

Enter the directory and file name, afterwards select "OK"

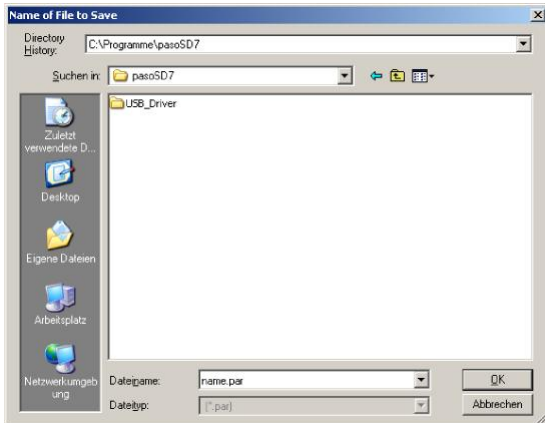

If required, enter the corresponding values to "Operator" and "Remarks", afterwards select "OK"

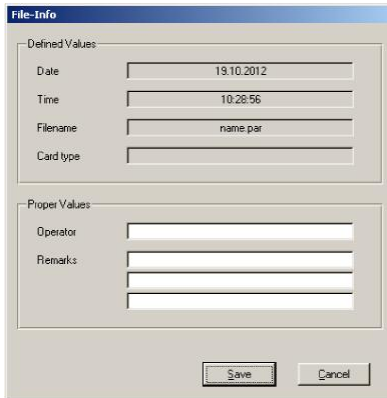

In the header line the corresponding file name appears

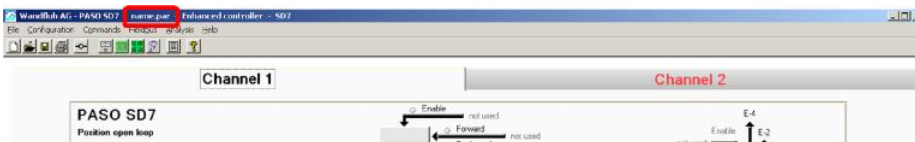

10.19 Activate PASO On Line mode

Select "File - Activate On Line"

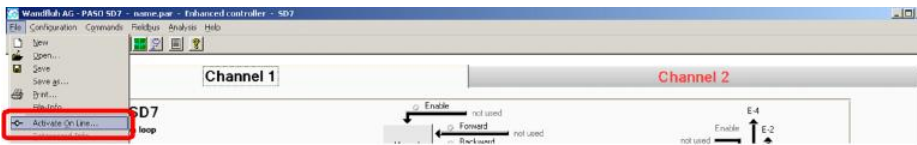

Select "Program the Wandfluh-Electronic with the new actual data?"

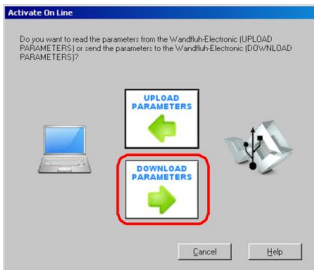

Select "OK"

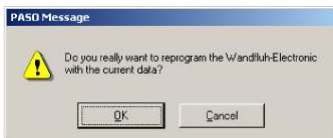

Select "OK"

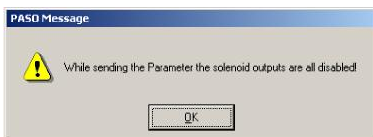

Wait, until all parameters are sent to the MD2 Electronics

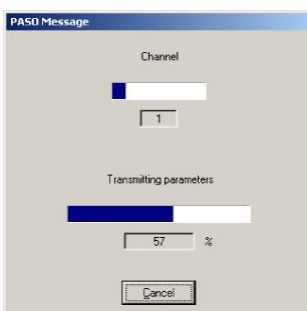

In the status line the message "On-Line" appears

